

Delivery address: Mackenrodtstraße 14,
36039 Fulda, Germany
Postal address: 36035 Fulda, Germany
Phone: +49 661 6003-0
Fax: +49 661 6003-607
e-mail: mail@jumo.net
Internet: www.jumo.net

JUMO House
Temple Bank, Riverway
Harlow, Essex CM 20 2TT, UK
Phone: +44 1279 635533
Fax: +44 1279 635262
e-mail: sales@jumo.co.uk
Internet: www.jumo.co.uk

885 Fox Chase, Suite 103
Coatesville PA 19320, USA
Phone: 610-380-8002
1-800-554-JUMO
Fax: 610-380-8009
e-mail: info@JumoUSA.com
Internet: www.JumoUSA.com



Construction and application of thermocouples

The thermoelectric effect

The effect responsible for the action of thermocouples is the **Seebeck effect**. If a temperature difference exists along a wire, this will cause a displacement of electrical charge. The amount of the charge displacement depends on the electrical characteristics of the chosen material. If two wires of different materials are joined at one point and then subjected to a temperature, then a voltage difference will be generated between the open ends of the two wires. This voltage depends on the temperature difference along the two wires. In order to be able to measure the temperature at the junction, the temperature at the open end must be known. If the temperature of the open end is not known, then it must be extended (by a compensating cable) into the zone of known temperature (reference junction, usually referred to as the "cold junction").

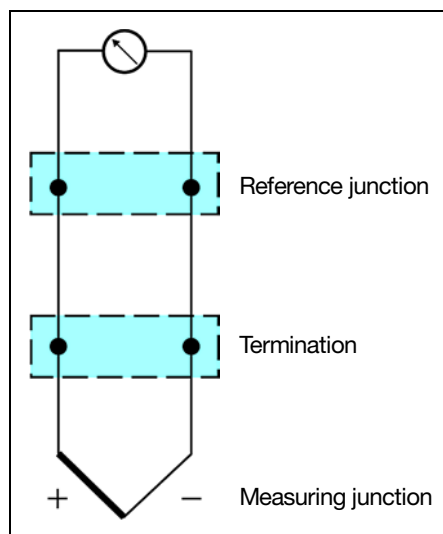

Fig. 1: Measuring circuit (schematic)

The temperature of the reference junction must be known and constant. If no constant reference junction temperature is available, the reference junction has to be arranged as a thermostat, or its temperature has to be determined by means of a second sensor.

Thermocouples to EN 60584 and DIN 43710

From the variety of possible metal combinations, certain ones have been selected (Tables 1 and 2) and their voltage tables and permitted tolerances incorporated in standard specifications (Fig. 2 and Tables 3 and 4).

Note that two Fe-Con thermocouples (Type J and L) and two Cu-Con thermocouples

Thermocouple	Maximum temperature	Defined up to	Positive limb	Negative limb
Fe-Con J	750°C	1200°C	black	white
Cu-Con T	350°C	400°C	brown	white
NiCr-Ni K	1200°C	1370°C	green	white
NiCr-Con E	900°C	1000°C	violet	white
NiCrSi-NiSi N	1200°C	1300°C	mauve	white
Pt10Rh-Pt S	1600°C	1540°C	orange	white
Pt13Rh-Pt R	1600°C	1760°C	orange	white
Pt30Rh-Pt6Rh B	1700°C	1820°C	no data	white

Table 1: Thermocouples to EN 60584

Thermocouple	Maximum temperature	Defined up to	Positive limb	Negative limb
Fe-Con L	700°C	900°C	red	blue
Cu-Con U	400°C	600°C	red	brown

* Continuous temperature in pure air

Table 2: Thermocouples to DIN 43710

(Type T and U) have been standardized in both EN 60584 and DIN 43710. The "old" thermocouples L and U are now being used less frequently than the thermocouples J and T to EN 60584.

The individual thermocouples are not compatible, because of their differing alloy compositions. If a Fe-Con thermocouple Type L is connected to an instrument linearized for Type J, the difference in the thermal voltages leads to errors of up to several °C. The same applies to thermocouples Type U and T.

The maximum temperature represents the limit to which a tolerance is specified. The value under "defined to" is the temperature limit to which the thermal voltage is covered by standard specifications. In the thermocouples listed above, the first limb is always the positive one. The color codes apply both to the thermocouple itself and to the compensating cables. If the thermocouple wires are not color coded, the following differences may help to identify them.

- Fe-Con: positive limb is magnetic
- Cu-Con: positive limb is copper colored
- NiCr-Ni: negative limb is magnetic
- PtRh-Pt: negative limb is softer

These distinctions do not apply to the compensating cables. The thermocouples are insulated inside the fittings using ceramic materials. PVC, silicone, PTFE or glass fiber are used in the cables.

Tolerances

EN 60584 defines three tolerance classes for thermocouples. They normally apply to thermowires between 0.25 to 3mm diameter and to the condition as supplied. The standard cannot cover any possible subsequent ageing, since this largely depends on the conditions of use. The temperature limits specified for the tolerance classes are not necessarily the recommended operating temperature limits (see Tables 3 and 4). The larger value applies in each case.

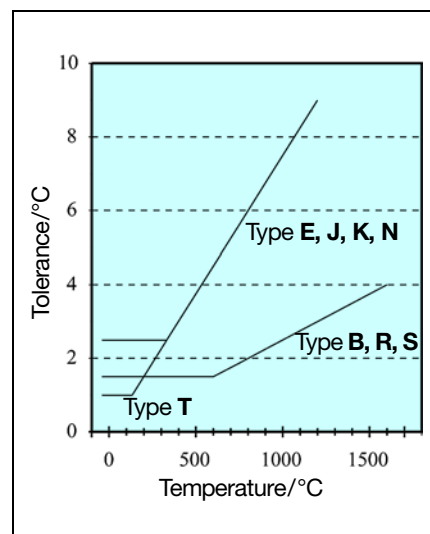

Fig. 2: Tolerances

Delivery address: Mackenrodtstraße 14,
36039 Fulda, Germany
Postal address: 36035 Fulda, Germany
Phone: +49 661 6003-0
Fax: +49 661 6003-607
e-mail: mail@jumo.net
Internet: www.jumo.net

JUMO House
Temple Bank, Riverway
Harlow, Essex CM 20 2TT, UK
Phone: +44 1279 635533
Fax: +44 1279 635262
e-mail: sales@jumo.co.uk
Internet: www.jumo.co.uk

885 Fox Chase, Suite 103
Coatesville PA 19320, USA
Phone: 610-380-8002
1-800-554-JUMO
Fax: 610-380-8009
e-mail: info@JumoUSA.com
Internet: www.JumoUSA.com



Linearity

The voltage produced by a thermocouple is not linear with temperature and must therefore be linearized by the subsequent electronics. Digital instruments are programmed with linearization tables, or appropriate calibration values have to be entered by the user. Analog instruments are often provided with non-linear scales. The characteristics of thermocouples (Fig. 3) are defined by voltage tables to ensure full interchangeability.

This means, for example, that a Fe-Con thermocouple Type J can be replaced by any other thermocouple of this type irrespective of the manufacturer, without requiring any recalibration of the instrument to which it is connected.

Compensating cables to EN and DIN

Compensating cables for thermocouples have their electric and mechanical properties defined in the EN 60 584 or DIN 43 714 standards. They are made either of the same material as the thermocouple itself (thermocables, extension cables) or from special materials with the same thermoelectric properties within restricted temperature ranges (compensating cables proper). The use of compensating cables saves the extra cost in the case of certain noble metals.

Compensating cables consist of twisted cores and are identified by a color code and code letters as follows:

- Letter 1: code letter for the thermocouple
- Letter 2: X: same material as thermocouple
C: special material
- Letter 3: several types of compensating cable can be distinguished by a third letter.

Example:

- KX: compensating cable for NiCr-Ni thermocouple Type K made from thermocouple material
- RCA: compensating cable for PtRh-Pt thermocouple Type R, made from special material Type A

Thermocouple		Tolerance classes		
Fe-Con	J	Class 1	- 40 to + 750°C: ±0.004 x t	or ±1.5°C
		Class 2	- 40 to + 750°C: ±0.0075 x t	or ±2.5°C
		Class 3		
Cu-Con	T	Class 1	- 40 to + 350°C: ±0.004 x t	or ±0.5°C
		Class 2	- 40 to + 350°C: ±0.0075 x t	or ±1.0°C
		Class 3	-200 to + 40°C: ±0.0015 x t	or ±1.0°C
Ni-CrNi and NiCrSi-NiSi	K and N	Class 1	- 40 to +1000°C: ±0.004 x t	or ±1.5°C
		Class 2	- 40 to +1200°C: ±0.0075 x t	or ±2.5°C
NiCr-Con	E	Class 1	- 40 to + 800°C: ±0.004 x t	or ±1.5°C
		Class 2	- 40 to + 900°C: ±0.0075 x t	or ±2.5°C
		Class 3	-200 to + 40°C: ±0.015 x t	or ±2.5°C
Pt10Rh-Pt and Pt13Rh-Pt	S and R	Class 1	0 to +1600°C: ±[(t-1100) x 0.003]	or ±1.0°C
		Class 2	- 40 to +1600°C: ±0.0025 x t	or ±1.5°C
Pt30Rh-Pt6Rh	B	Class 1		
		Class 2	+600 to +1700°C: ±0.0025 x t	or ±1.5°C
		Class 3	+600 to +1700°C: ±0.005 x t	or ±4.0°C

Table 3: Tolerances to EN 60 584

Thermocouple		Tolerances	
Cu-Con	U	+100 to +400 °C:	±3°C
		+400 to +600 °C:	±0.0075 x t
Fe-Con	L	+100 to +400 °C:	±3°C
		+400 to +900 °C:	±0.0075 x t

Table 4: Tolerances to DIN 43 710 (1977)

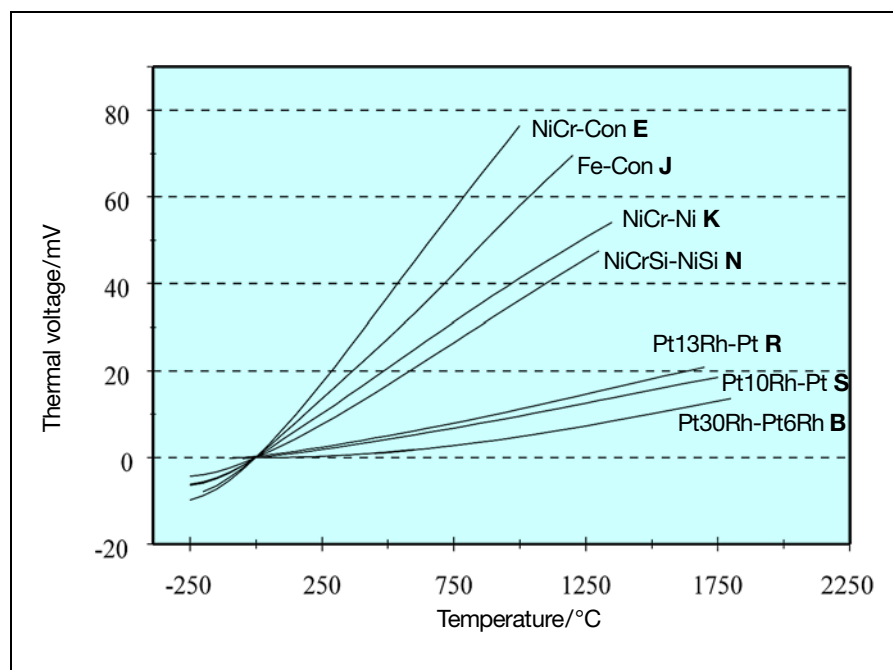

Fig. 3: Characteristics of thermocouples to EN 60 584

The tolerance classes 1 and 2 are defined for compensating cables. Class 1 has closer tolerances, which can only be met by extension cables made from the same material as the thermocouple, i.e. the X-type.

Compensating cables proper are normally supplied to Class 2. Table 5 shows the tolerances for the different compensating cable classes.

Delivery address: Mackenrodtstraße 14,
36039 Fulda, Germany
Postal address: 36035 Fulda, Germany
Phone: +49 661 6003-0
Fax: +49 661 6003-607
e-mail: mail@jumo.net
Internet: www.jumo.net

JUMO House
Temple Bank, Riverway
Harlow, Essex CM 20 2TT, UK
Phone: +44 1279 635533
Fax: +44 1279 635262
e-mail: sales@jumo.co.uk
Internet: www.jumo.co.uk

885 Fox Chase, Suite 103
Coatesville PA 19320, USA
Phone: 610-380-8002
1-800-554-JUMO
Fax: 610-380-8009
e-mail: info@JumoUSA.com
Internet: www.JumoUSA.com



The operating temperature range in Table 5 covers the temperature to which the entire cable may be exposed, including the thermocouple terminations, without exceeding the specified tolerances. Because of the non-linearity of the thermal voltage, the tolerances in mV or °C only apply to the measured temperatures specified in the right column.

This means, for example:

A thermocouple Type J is connected to a compensating cable Type JX, Class 2. If the measured temperature remains constant at 500°C and the temperature of the terminals and/or the compensating cable varies from -25 to +200°C, then the indicated temperature varies by not more than ±2.5°C.

Color coding of compensating cables

The color coding of compensating cables is laid down in EN 60584 and DIN 43713 (1990). For thermocouples to EN 60584 (Table 6) this means:

The positive limb has the same color as the sheath, the negative limb is white. The "old" thermocouples Type L and U to DIN 43713 (Table 7) are coded differently.

There are no details for the Pt30Rh-Pt6Rh thermocouple Type B. Ordinary copper connecting cables (plain copper) can be used as compensating cables in this case.

According to DIN 43714, the cable cores are twisted together for electromagnetic screening. Additional screening by foil or braiding can be provided. The insulation resistance between the cores and between cores and screening must not be less than 10⁷Ω x m⁻¹ at the maximum temperature; the breakdown voltage exceeds 500 VAC.

In addition to these color codes for compensating cables, there are also those according to DIN 43714, 1979 (Table 8). They differ in certain respects from the ones mentioned above.

Where there are no color codes, it is not possible to identify cables by magnetism, color or hardness. Compensating cables Type KCA and KCB differ from the thermocable KX and the thermocouple Type K by having a magnetic positive limb.

Thermocouple and wire type	Tolerance classes		Operating temperature range [°C]	Measuring temperature [°C]
	1	2		
JX	± 85µV/±1.5°C	± 140µV/±2.5°C	-25 to +200	500
TX	± 30µV/±0.5°C	± 60µV/±1.0°C	-25 to +100	300
EX	± 120µV/±1.5°C	± 200µV/±2.5°C	-25 to +200	500
KX	± 60µV/±1.5°C	± 100µV/±2.5°C	-25 to +200	900
NX	± 60µV/±1.5°C	± 100µV/±2.5°C	-25 to +200	900
KCA	-	± 100µV/±2.5°C	0 to +150	900
KCB	-	± 100µV/±2.5°C	0 to +100	900
NC	-	± 100µV/±2.5°C	0 to +150	900
RCA	-	± 30µV/±2.5°C	0 to +100	1000
RCB	-	± 60µV/±5.0°C	0 to +200	1000
SCA	-	± 30µV/±2.5°C	0 to +100	1000
SCB	-	± 60µV/±5.0°C	0 to +200	1000

Table 5: Tolerances for thermocables and compensating cables

Thermocouple	Type	Sheath	Positive limb	Negative limb
Cu-Con	T	brown	brown	white
Fe-Con	J	black	black	white
NiCr-Ni	K	green	green	white
NiCrSi-NiSi	N	mauve	mauve	white
NiCr-Con	E	violet	violet	white
Pt10Rh-Pt	S	orange	orange	white
Pt13Rh-Pt	R	orange	orange	white

Table 6: Color coding for thermocouples to EN 60584

Thermocouple	Type	Sheath	Positive limb	Negative limb
Fe-Con	L	blue	red	blue
Cu-Con	U	brown	red	brown

Table 7: Color coding for thermocouples to DIN 43713

Thermocouple	Type	Sheath	Positive limb	Negative limb
NiCr-Ni	K	green	red	green
Pt10Rh-Pt	S	white	red	white
Pt13Rh-Pt	R	white	red	white

Table 8: Color coding for thermocouples to DIN 43714 (1979)



Construction of thermocouples

Apart from the virtually unlimited number of special models, there are also those whose components are completely defined by standard specifications.

Thermocouples with terminal head

These **thermocouples** are of modular construction, consisting of the thermocouple proper, insert tube, terminal plate, protection tube and the terminal head. A flange or a screw fitting can be provided for mounting in position.

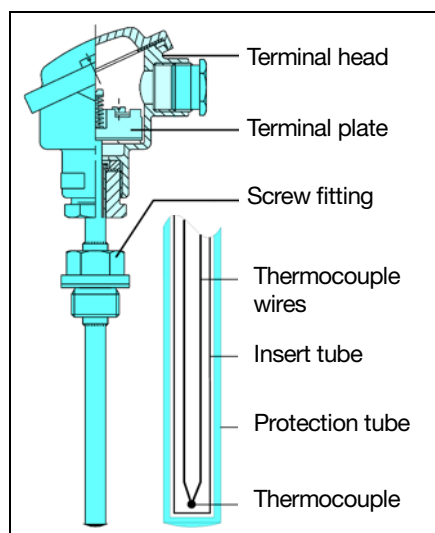

Fig. 4: Construction of a thermocouple

The **measuring insert** is a completely fabricated unit consisting of thermocouple sensor and terminal plate, with the thermocouple contained in an **insert tube** of 6 or 8 mm diameter made from bronze SnBz6 to DIN 17 681 (up to 300°C) or nickel. It is inserted into the actual protection tube, which is often made from stainless steel. The tip of the insert tube is in full contact with the inside of the protection tube end plate in order to ensure good heat transfer. The fixing screws of the insert are backed by springs, to maintain good contact even with differential expansion between insert tube and protection tube. This arrangement ensures that the insert can be readily replaced.

The thermometers are available in single and twin versions. Their dimensions are laid down in DIN 43 735. If no measuring insert is used, the thermocouple is mounted directly in the **protection tube** using ceramic insulation.

The choice of the protection tube material depends on the thermal, chemical and mechanical conditions on site.

Metal protection tubes in high-temperature steel, e.g. Material Ref. 1.4749, are used up to 1150°C. The corrosion resistance of the protection tube materials is described in DIN 43 720.

These details are provided for general information only, and the user remains responsible for fully evaluating the protection tube material for its suitability to the operating conditions on site. The indicated temperature refers to the use without mechanical loads and (unless otherwise specified) in clean air.

Ceramic protection tubes are employed where local conditions prevent the use of metal fittings, either for chemical reasons or because of high temperatures. Their main application is at temperatures between 1000 and 1650°C. They may be in direct contact with the medium, or may be used as a gas-tight inner tube to separate the thermocouple from the actual protection tube. Even hair cracks may lead to a poisoning and drifting of the thermocouple. The resistance of a ceramic to temperature shock increases with its thermal conductivity and the tensile strength, and is larger for a lower thermal expansion coefficient. The wall thickness of the material is also important; thin-walled tubes are preferable to those with larger wall thicknesses.

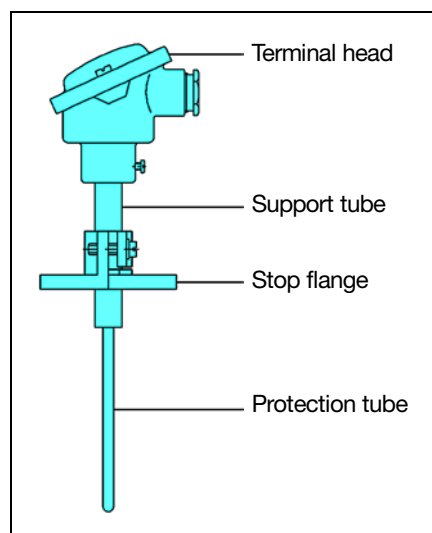

Fig. 5: Thermocouple with ceramic protection tube

In the case of noble thermocouples, the ceramic has to be of the highest purity.

Platinum thermocouples are very sensitive to poisoning by foreign chemical elements. These include especially silicon, arsenic, phosphorus, sulfur and boron. Special care must therefore be taken in

high-temperature fittings to ensure that insulation and protection tube do not contain such elements, as far as this is possible. A particularly damaging material is SiO₂. Poisoning takes place much more rapidly in a neutral or reducing atmosphere and is caused by the reduction of SiO₂ to SiO, which reacts with platinum to form Pt₅Si₂. As little as 0.2% SiO₂ in the insulation of the protection tube material is sufficient in a reducing atmosphere to form such brittle silicides.

Thermocouples with protection tubes that are permeable to gas can therefore not be used in a reducing atmosphere, such as in annealing furnaces, but are permitted in an oxidizing atmosphere or under a protective gas blanket. If an inner tube of gas-tight ceramic is used, the outer protection tube can be permeable to gas.

In the high-temperature range, the insulation properties of the materials become important. Protection tubes in aluminium-oxide (KER 610) and magnesium oxide exhibit appreciable conductivity above 1000°C. This produces a shunt effect which introduces errors into the thermocouple signal. The insulation of ceramics deteriorates with increasing alkali content. Pure aluminium oxide ceramics exhibit the best characteristics. KER 710 is therefore used for 4-bore insulators and protection tubes.

Two gas-tight ceramics are described below, whose characteristics are defined in DIN 43 724:

KER 710 is a pure oxide ceramic consisting of more than 99.7% Al₂O₃, with traces of MgO, Si₂O and Na₂O, which is fire resistant up to 1900°C and has a melting point of 2050°C. It is the best ceramic material, with an insulation resistance of 10⁷Ω x cm at 1000°C and good strength under alternating temperatures, thanks to its high thermal conductivity and relatively low thermal expansion. With platinum thermocouples, both the insulation rod and the protection tube must be in KER 710.



The material **KER 610** has a higher alkali content (60% Al₂O₃, 37% SiO₂, 3% alkali) and, therefore, a low insulation resistance of about 10⁴Ω x cm at 1000°C. Because of the high silicon dioxide content, it cannot be used in a reducing atmosphere. Compared with KER 710, it has only one-ninth the thermal conductivity; its mechanical stability is good.

The advantage of KER 610 is its price, which is only about one-fifth that of KER 710.

For the **terminal heads**, DIN 43729 defines the two forms A and B, which differ in size and also slightly in style.

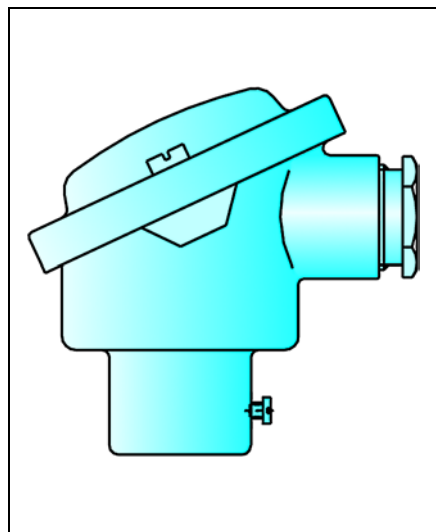

Fig. 6: Terminal head to DIN 43729, Form B

The material used is aluminium.

Protection is not covered by a standard; it is usually splash-proof to IP54. The nominal diameter of the bore to take the protection tube is as follows:

- Form A: 22, 24 or 32 mm.
- Form B: 15 mm or thread M 24 x 1.5.

Thermocouples to DIN 3440

Thermocouples for use with temperature controllers or temperature limiters for indirect heating systems must meet the requirements of DIN 3440 and are subject to additional TUV approval.

The thermocouples must withstand temperatures that are 15% above the upper temperature limit for at least one hour and have to meet certain response times in re-

lation to the medium (e.g. air t_{0,63} = 120sec). The thermometers are designed to withstand mechanical loads caused by external pressure and the flow velocity of the medium at the operating temperature. No modifications to the thermometers are permitted without obtaining a fresh TUV approval!

Thermocouples with compensating cable

Thermocouples with an attached compensating cable do not have a measuring insert or a terminal head. The thermocouple is directly connected to the thermocable and enclosed in the protection tube. Strain relief is provided by crimping the protection tube at the entry of the compensating cable.

The thermocouple is normally insulated; alternatively, it can be welded to the protection tube tip for improved thermal contact. The maximum temperature is determined mainly by the thermal stability of the cable sheath and insulation. Table 9 shows as examples some insulation materials and their upper temperature limit.

Material	Max. temperature °C
PVC	80
Silicone	180
PTFE	260
Glass fiber	350

Table 9: Temperature limits of insulation materials

There are many different thermometer designs, and they are often adapted to suit particular customer requirements.

Some characteristic data are given below:

- diameter: 0.5 – 6mm
- protection tube length: 35 – 150mm
- protection tube material: stainless steel, heat-resistant steel or brass
- mounting: fixed or sliding flange, fixed thread or clamp

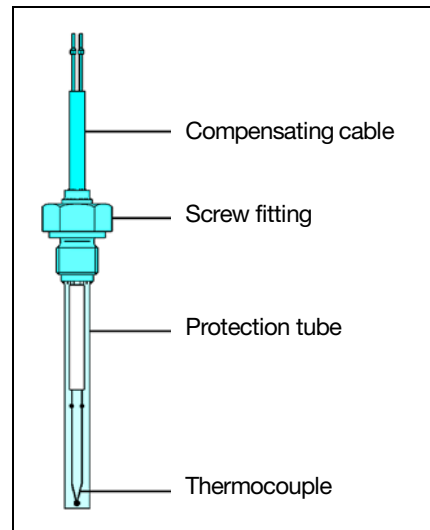

Fig. 7: Construction of a thermocouple with compensating cable

Thermocouples with bayonet fitting

Another version incorporates a bayonet fitting. The stainless steel pressure spring (Material Ref. 1.4310) also acts as a cable protector and ensures uniform pressure of the protection tube and sensing tip against the bottom of the bore.

The fitting length can be varied by rotating the bayonet lock. Bayonet fittings and sockets are available in 12, 15 and 16 mm diameters.

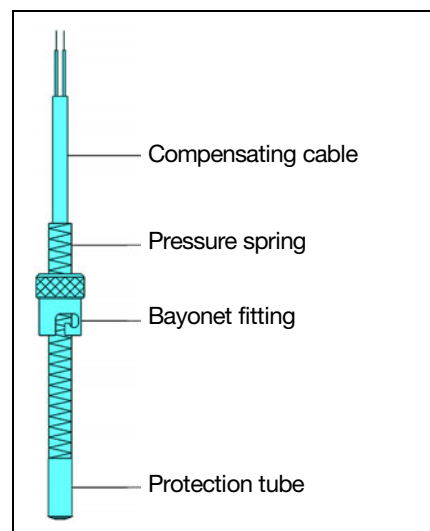

Fig. 8: Thermocouple with bayonet fitting



Thermocouples with a bayonet fitting are largely employed for measuring temperatures in solids, on bearings and moulding tools, e.g. in the plastics industry. Because of the special shape of the sensing tip, these thermocouples are suitable for both flat-bottom and cone-shaped bores.

Mineral-insulated thermocouples

Mineral-insulated thermocouples consist of a thin-walled sheath of stainless or high-temperature steel (Inconel 600) in which thermocouple wires are embedded in compressed fire-resistant magnesium oxide.

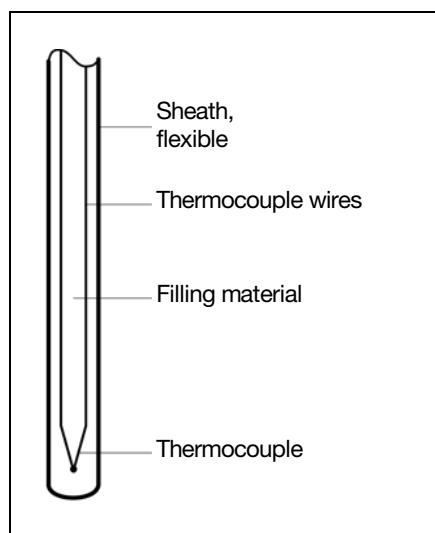

Fig. 9: Construction of a mineral-insulated thermocouple

Excellent heat transfer between sheath and thermocouple enables a fast response ($t_{0.5}$ from 0.1sec) and high accuracy.

The shock-resistant construction ensures a long life.

The flexible **sheath**, minimum bending radius 5 times the external diameter of 0.5 – 6mm, permits temperature measurement in locations where access is difficult. Thanks to their special features, mineral-insulated thermocouples are used in chemical plant, power stations, pipelines, on test beds and wherever resistance to vibration, flexibility and easy installation are required.

Connection of thermocouples

The length of the compensating cable is of minor importance in view of the low internal resistance. With long distances and a small cross-section, the resistance of the compensating cable may, however, become relatively large.

In order to avoid errors, the resistance of the input circuit of the instrument must be

at least 1000 times the resistance of the thermocouple connected.

It is essential to use only compensating cables of the same material as the thermocouple, or with the same thermoelectric characteristics, otherwise an additional thermocouple is formed at the connection point. The compensating cable has to be run up to the cold junction. The correct polarity must be observed when connecting up the thermocouple.

Effect on short-circuit and break

A thermocouple produces no voltage if the measured temperature is equal to the cold junction temperature.

If a thermocouple or compensating cable is short-circuited, a new measuring point is produced at the location of the short-circuit. If it occurs in the terminal head, for example, the temperature measurement relates not to the actual measuring point, but to the terminal head. If there is a break in the measuring circuit, the instrument will show the cold junction temperature.

Measurement errors arising from the installation

A temperature probe can only indicate the temperature of its temperature-sensitive sensor. This temperature is not necessarily the same as that for the medium which is intended to be measured. The thermometer is not installed purely in the medium, but is also thermally linked to its surroundings. This results in a temperature shift (thermal conduction error). This error depends on a number of factors. These include: the temperature of the medium, ambient temperature, thermal characteristics of the medium, flow velocity and the immersion length of the thermometer. A lasting reduction of this error requires a suitable choice of installation site, whereby the immersion depth of the thermometer in the medium plays a particularly important role. As a rough guide for measurement in liquid media, the immersion depth should be at least 15 times the thermometer diameter. For critical applications, or to meet requirements for very high accuracy, the installation-induced error should be checked by a test measurement. To do this, the thermometer is pulled out of the normal installation position by about 10 mm, and the temperature indication is noted.

Fault finding

One of the most frequent faults is the omission or the incorrect choice of the compensating cable. The thermocouple can be readily checked using a simple continuity tester or ohmmeter. The operation of the thermocouple and its correct polarity can be tested with a voltmeter (millivolt range), by heating its sensing tip.

Possible connection errors and their effects:

- *Indicator shows room temperature thermocouple or cable open-circuit.*
- *Indication has correct value but negative sign*
- *Indication clearly too high or too low*
 - a) incorrect linearization of the indicator.
 - b) incorrect compensating cable or connections reversed.
- *Indication too high or too low by a fixed amount*
- *Indication correct but drifting slowly in spite of constant measured temperature*
- *cold junction temperature not constant or not evaluated correctly.*
- *Temperature still indicated with one limb disconnected*
 - a) electromagnetic interference picked up on the input cable.
 - b) parasitic voltages produced due to missing or faulty electrical isolation e.g. in furnaces.
- *High reading when both thermocouple limbs are disconnected*
 - a) electromagnetic interference picked up on the input cable
 - b) parasitic galvanic voltages, e.g. due to damp insulation in the compensating cable.

Delivery address: Mackenrodtstraße 14,
36039 Fulda, Germany
Postal address: 36035 Fulda, Germany
Phone: +49 661 6003-0
Fax: +49 661 6003-607
e-mail: mail@jumo.net
Internet: www.jumo.net

JUMO House
Temple Bank, Riverway
Harlow, Essex CM 20 2TT, UK
Phone: +44 1279 635533
Fax: +44 1279 635262
e-mail: sales@jumo.co.uk
Internet: www.jumo.co.uk

885 Fox Chase, Suite 103
Coatesville PA 19320, USA
Phone: 610-380-8002
1-800-554-JUMO
Fax: 610-380-8009
e-mail: info@JumoUSA.com
Internet: www.JumoUSA.com



Safety notes

All welded joints on thermometers and pockets are monitored through a quality assurance system to DIN 8563, Part 113. Special regulations apply to certain applications (e.g. pressure vessels) according to Section 24 of the German Trade Regulations. Where the user specifies such special requirements, the weld is monitored according to EN 287 and EN 288.

Pressure loading for temperature probes

The pressure resistance of protection fittings, such as are used for electric thermometers, depends largely on the different process parameters.

These include:

- temperature
- pressure
- flow velocity
- vibration

In addition, physical properties, such as material, fitting length, diameter and type of process connection have to be taken into account.

The following diagrams are taken from DIN 43763 and show the load limit for the different basic types in relation to the temperature and the fitting length, as well as the flow velocity, temperature and medium

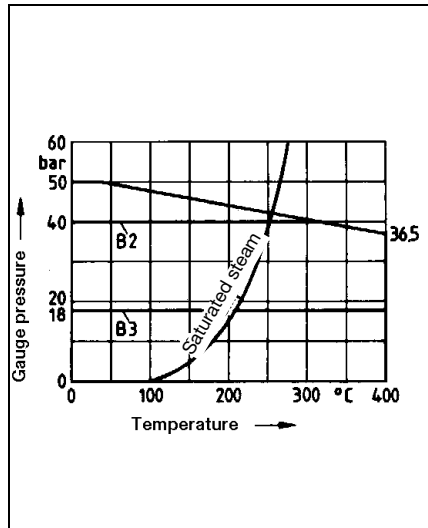

Fig. 10: Pressure loading for protection tube Form B

stainless steel 1.4571
velocity up to 25m/sec in air
velocity up to 3m/sec in water

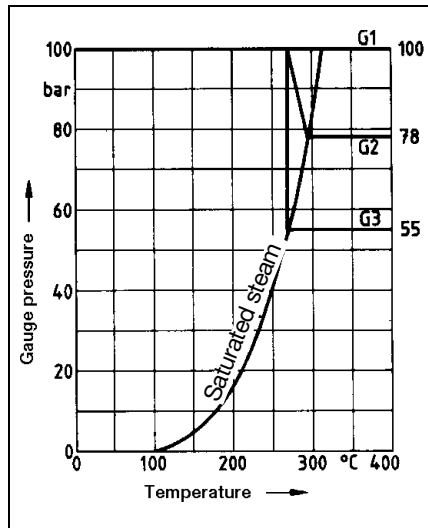

Fig. 11: Pressure loading for protection tube Form G

stainless steel 1.4571
velocity up to 40m/sec in air
velocity up to 4m/sec in water

Delivery address: Mackenrodtstraße 14,
36039 Fulda, Germany
Postal address: 36035 Fulda, Germany
Phone: +49 661 6003-0
Fax: +49 661 6003-607
e-mail: mail@jumo.net
Internet: www.jumo.net

JUMO House
Temple Bank, Riverway
Harlow, Essex CM 20 2TT, UK
Phone: +44 1279 635533
Fax: +44 1279 635262
e-mail: sales@jumo.co.uk
Internet: www.jumo.co.uk

885 Fox Chase, Suite 103
Coatesville PA 19320, USA
Phone: 610-380-8002
1-800-554-JUMO
Fax: 610-380-8009
e-mail: info@JumoUSA.com
Internet: www.JumoUSA.com



As explained in the standard, the values indicated are guide values, which have to be individually examined for the specific application. Slight differences in the measurement conditions may suffice to destroy the protection tube.

If, when ordering an electric thermometer, the protection fitting needs to be checked, the load type and the limit values must be specified.

Fig. 12 shows the load limits (guide values) for different tube dimensions on a variety of additional thermometer designs. The maximum pressure loading of cylindrical protection tubes is shown in relation to the wall thickness with different tube diameters.

The data refer to protection tubes in stainless steel 1.4571, 100mm fitting length, 10m/sec flow velocity in air, or 4m/sec in water, and a temperature range from -20 to +100°C. A safety factor of 1.8 has been taken into account. For higher temperatures or different materials, the maximum pressure loading has to be reduced by the percentage values given in the table.

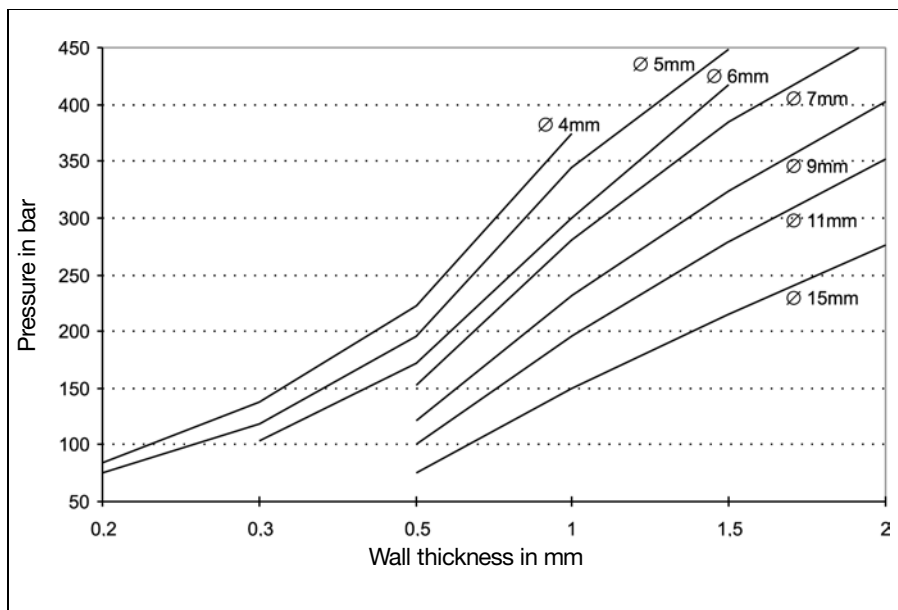

Fig. 12: Load limits on protection tubes for various tube dimensions

Material	Temperature	Reduction
CrNi 1.4571	up to +200°C	-10%
CrNi 1.4571	up to +300°C	-20%
CrNi 1.4571	up to +400°C	-25%
CrNi 1.4571	up to +500°C	-30%
CuZn 2.0401	up to +100°C	-15%
CuZn 2.0401	up to +175°C	-60%

Delivery address: Mackenrodtstraße 14,
36039 Fulda, Germany
Postal address: 36035 Fulda, Germany
Phone: +49 661 6003-0
Fax: +49 661 6003-607
e-mail: mail@jumo.net
Internet: www.jumo.net

JUMO House
Temple Bank, Riverway
Harlow, Essex CM 20 2TT, UK
Phone: +44 1279 635533
Fax: +44 1279 635262
e-mail: sales@jumo.co.uk
Internet: www.jumo.co.uk

885 Fox Chase, Suite 103
Coatesville PA 19320, USA
Phone: 610-380-8002
1-800-554-JUMO
Fax: 610-380-8009
e-mail: info@JumoUSA.com
Internet: www.JumoUSA.com



Pressure test for thermometer protection fittings

The welded protection fittings of JUMO thermometers are subjected to a leakage test or a pressure test, depending on the construction of the protection fitting.

Thermometers which are manufactured to DIN or to application-specific guidelines (chemical or petrochemical plant, pressure vessel regulation, steam boilers) require different pressure tests according to the specific application.

If the thermometers are to be manufactured to such standards or guidelines, then the required tests or standards and/or guidelines have to be specified when ordering.

Scope of test

Tests can be carried out on each individual protection fitting and documented in a test report or acceptance certificate to EN 10204 (at extra cost).

Type of test

Tests can be performed on protection fittings up to a fitting length of 1050mm with flange connection DN25 or screw connection up to 1" thread size.

The following tests can be carried out:

Test type	Test medium	Pressure range	Test duration
Leakage test	helium	vacuum	10sec
Pressure test I	nitrogen	1 – 50bar	10sec
Pressure test II	water	50 – 300bar	10sec

Leakage test

A vacuum is produced inside the protection tube. From the outside, helium is applied to the protection fitting. If there is a leak in the protection tube, helium will penetrate and will be recognized through analysis. A leakage rate is determined by the rise in pressure (leakage rate > 1 x 10⁻⁶ l/bar).

Pressure test I

A positive pressure of nitrogen is applied to the protection tube from the outside. If there is a leak in the fitting, a volume flow will be produced inside the protection tube, which will be recognized.

Pressure test II

Water pressure is applied to the protection tube from the outside. The pressure must remain constant for a certain length of time. If this is not the case, the protection fitting has a leak.

Qualified welding processes for the production of protection tubes for thermometers

In addition to using perfect materials, it is the joining technique which ultimately determines the mechanical stability and quality of the protection fittings. This is why the welding techniques at JUMO comply with the European Standards EN 287 and EN 288. Manual welding is carried out by qualified welders according to EN 287. Automatic welding processes are qualified by a WPS (welding instruction) to EN 288.

The following table gives an overview of qualified welding processes:

Material	WIG welding	
	manual	automatic
W11, W11 with W01-W04 to EN 287	Tube diameter 2 – 30mm Wall thickness 0.75 – 5.6mm	Tube diameter 5 – 10mm Wall thickness 0.5 – 1.0mm

Table 10: Qualified welding processes

Based on these experiences, our welders can also join different materials and dimensions.

Laser beam welding is employed for wall thicknesses of less than 0.6mm, which is monitored by a laser beam specialist according to guideline DSV 1187.

On customer request, material test certificates can be issued at extra cost. Likewise, special tests and treatments can be carried out, which are calculated according to the extent of the work, as set out in various application guidelines. This includes X-ray examinations, crack test (dye penetration test), thermal treatment, special cleaning processes and markings.

Delivery address: Mackenrodtstraße 14,
36039 Fulda, Germany
Postal address: 36035 Fulda, Germany
Phone: +49 661 6003-0
Fax: +49 661 6003-607
e-mail: mail@jumo.net
Internet: www.jumo.net

JUMO House
Temple Bank, Riverway
Harlow, Essex CM 20 2TT, UK
Phone: +44 1279 635533
Fax: +44 1279 635262
e-mail: sales@jumo.co.uk
Internet: www.jumo.co.uk

885 Fox Chase, Suite 103
Coatesville PA 19320, USA
Phone: 610-380-8002
1-800-554-JUMO
Fax: 610-380-8009
e-mail: info@JumoUSA.com
Internet: www.JumoUSA.com



Voltage table for thermocouples to EN 60 584

in mV for 10°C temperature steps (0°C cold junction)

Pt13Rh-Pt R										
°C	0	10	20	30	40	50	60	70	80	90
0	0	0.054	0.111	0.171	0.232	0.296	0.363	0.431	0.501	0.573
100	0.647	0.723	0.800	0.879	0.959	1.041	1.124	1.208	1.294	1.380
200	1.468	1.557	1.647	1.738	1.830	1.923	2.017	2.111	2.207	2.303
300	2.400	2.498	2.596	2.695	2.795	2.896	2.997	3.099	3.201	3.304
400	3.407	3.511	3.616	3.721	3.826	3.933	4.039	4.146	4.254	4.362
500	4.471	4.580	4.689	4.799	4.910	5.021	5.132	5.244	5.356	5.469
600	5.582	5.696	5.810	5.925	6.040	6.155	6.272	6.388	6.505	6.623
700	6.741	6.860	6.979	7.098	7.218	7.339	7.460	7.582	7.703	7.826
800	7.949	8.072	8.196	8.320	8.445	8.570	8.696	8.822	8.949	9.076
900	9.203	9.331	9.460	9.589	9.718	9.848	9.978	10.109	10.240	10.371
1000	10.503	10.636	10.768	10.902	11.035	11.170	11.304	11.439	11.574	11.710
1100	11.846	11.983	12.119	12.257	12.394	12.532	12.669	12.808	12.946	13.085
1200	13.224	13.363	13.502	13.642	13.782	13.922	14.062	14.202	14.343	14.483
1300	14.624	14.765	14.906	15.047	15.188	15.329	15.470	15.611	15.752	15.893
1400	16.035	16.176	16.317	16.458	16.599	16.741	16.882	17.022	17.163	17.304
1500	17.445	17.585	17.726	17.866	18.006	18.146	18.286	18.425	18.564	18.703
1600	18.842	18.981	19.119	19.257	19.395	19.533	19.670	19.807	19.944	20.080

Pt10Rh-Pt S										
°C	0	10	20	30	40	50	60	70	80	90
0	0	0.055	0.113	0.173	0.235	0.299	0.365	0.432	0.502	0.573
100	0.645	0.719	0.795	0.872	0.950	1.029	1.109	1.190	1.273	1.356
200	1.440	1.525	1.611	1.698	1.785	1.873	1.962	2.051	2.141	2.232
300	2.323	2.414	2.506	2.599	2.692	2.786	2.880	2.974	3.069	3.164
400	3.260	3.356	3.452	3.549	3.645	3.743	3.840	3.938	4.036	4.135
500	4.234	4.333	4.432	4.532	4.632	4.732	4.832	4.933	5.034	5.136
600	5.237	5.339	5.442	5.544	5.648	5.751	5.855	5.960	6.064	6.169
700	6.274	6.380	6.486	6.592	6.699	6.805	6.913	7.020	7.128	7.236
800	7.345	7.454	7.563	7.672	7.782	7.892	8.003	8.114	8.225	8.336
900	8.448	8.560	8.673	8.786	8.899	9.012	9.126	9.240	9.355	9.470
1000	9.585	9.700	9.816	9.932	10.048	10.165	10.282	10.400	10.517	10.635
1100	10.754	10.872	10.991	11.110	11.229	11.348	11.467	11.587	11.707	11.827
1200	11.947	12.067	12.188	12.308	12.429	12.550	12.671	12.792	12.913	13.034
1300	13.155	13.276	13.397	13.519	13.640	13.761	13.883	14.004	14.125	14.247
1400	14.368	14.489	14.610	14.731	14.852	14.973	15.094	15.215	15.336	15.456
1500	15.576	15.697	15.817	15.937	16.057	16.176	16.296	16.415	16.534	16.653
1600	16.771	16.890	17.008	17.125	17.243	17.360	17.477	17.594	17.711	17.826

Pt30Rh-Pt6Rh B										
°C	0	10	20	30	40	50	60	70	80	90
0	0	-0.002	-0.003	-0.002	-0	0.002	0.006	0.011	0.017	0.025
100	0.033	0.043	0.053	0.065	0.078	0.092	0.107	0.123	0.140	0.159
200	0.178	0.199	0.220	0.243	0.266	0.291	0.317	0.344	0.372	0.401
300	0.431	0.462	0.494	0.527	0.561	0.596	0.632	0.669	0.707	0.746
400	0.786	0.827	0.870	0.913	0.957	1.002	1.048	1.095	1.143	1.192
500	1.241	1.292	1.344	1.397	1.450	1.505	1.560	1.617	1.674	1.732
600	1.791	1.851	1.912	1.974	2.036	2.100	2.164	2.230	2.296	2.363
700	2.430	2.499	2.569	2.639	2.710	2.782	2.855	2.928	3.003	3.078
800	3.154	3.231	3.308	3.387	3.466	3.546	3.626	3.708	3.790	3.873
900	3.957	4.041	4.126	4.212	4.298	4.386	4.474	4.562	4.652	4.742
1000	4.833	4.924	5.016	5.109	5.202	5.297	5.391	5.487	5.583	5.680
1100	5.777	5.875	5.973	6.073	6.172	6.273	6.374	6.475	6.577	6.680
1200	6.783	6.887	6.991	7.096	7.202	7.308	7.414	7.521	7.628	7.736
1300	7.845	7.953	8.063	8.172	8.283	8.393	8.504	8.616	8.727	8.839
1400	8.952	9.065	9.178	9.291	9.405	9.519	9.634	9.748	9.863	9.979
1500	10.094	10.210	10.325	10.441	10.558	10.674	10.790	10.907	11.024	11.141
1600	11.257	11.374	11.491	11.608	11.725	11.842	11.959	12.076	12.193	12.310
1700	12.426	12.543	12.659	12.776	12.892	13.008	13.124	13.239	13.354	13.470

Delivery address: Mackenrodtstraße 14,
36039 Fulda, Germany
Postal address: 36035 Fulda, Germany
Phone: +49 661 6003-0
Fax: +49 661 6003-607
e-mail: mail@jumo.net
Internet: www.jumo.net

JUMO House
Temple Bank, Riverway
Harlow, Essex CM 20 2TT, UK
Phone: +44 1279 635533
Fax: +44 1279 635262
e-mail: sales@jumo.co.uk
Internet: www.jumo.co.uk

885 Fox Chase, Suite 103
Coatesville PA 19320, USA
Phone: 610-380-8002
1-800-554-JUMO
Fax: 610-380-8009
e-mail: info@JumoUSA.com
Internet: www.JumoUSA.com



Voltage table for thermocouples to EN 60 584

in mV for 10°C temperature steps (0°C cold junction)

Cu-Con T										
°C	0	-10	-20	-30	-40	-50	-60	-70	-80	-90
-200	-5.603	-	-	-	-	-	-	-	-	-
-100	-3.378	-3.656	-3.923	-4.177	-4.419	-4.648	-4.865	-5.069	-5.261	-5.439
0	0	-0.383	-0.757	-1.121	-1.475	-1.819	-2.152	-2.475	-2.788	-3.089

°C	0	10	20	30	40	50	60	70	80	90
0	0	0.391	0.789	1.196	1.611	2.035	2.467	2.908	3.357	3.813
100	4.277	4.749	5.227	5.712	6.204	6.702	7.207	7.718	8.235	8.757
200	9.286	9.820	10.360	10.905	11.456	12.011	12.572	13.137	13.707	14.281
300	14.860	15.443	16.030	16.621	17.217	17.816	18.420	19.027	19.638	20.252

Fe-Con J										
°C	0	-10	-20	-30	-40	-50	-60	-70	-80	-90
-200	-7.890	-	-	-	-	-	-	-	-	-
-100	-4.632	-5.036	-5.426	-5.801	-6.159	-6.499	-6.821	-7.122	-7.402	-7.659
0	0	-0.501	-0.995	-1.481	-1.960	-2.431	-2.892	-3.344	-3.785	-4.215

°C	0	10	20	30	40	50	60	70	80	90
0	0	0.507	1.019	1.536	2.058	2.585	3.115	3.649	4.186	4.725
100	5.268	5.812	6.359	6.907	7.457	8.008	8.560	9.113	9.667	10.222
200	10.777	11.332	11.887	12.442	12.998	13.553	14.108	14.663	15.217	15.771
300	16.325	16.879	17.432	17.984	18.537	19.089	19.640	20.192	20.743	21.295
400	21.846	22.397	22.949	23.501	24.054	24.607	25.161	25.716	26.272	26.829
500	27.388	27.949	28.511	29.075	29.642	30.210	30.782	31.356	31.933	32.513
600	33.096	33.683	34.273	34.867	35.464	36.066	36.671	37.280	37.893	38.510
700	39.130	39.754	40.382	41.013	41.647	42.283	42.922	43.563	44.207	44.852

Delivery address: Mackenrodtstraße 14,
36039 Fulda, Germany
Postal address: 36035 Fulda, Germany
Phone: +49 661 6003-0
Fax: +49 661 6003-607
e-mail: mail@jumo.net
Internet: www.jumo.net

JUMO House
Temple Bank, Riverway
Harlow, Essex CM 20 2TT, UK
Phone: +44 1279 635533
Fax: +44 1279 635262
e-mail: sales@jumo.co.uk
Internet: www.jumo.co.uk

885 Fox Chase, Suite 103
Coatesville PA 19320, USA
Phone: 610-380-8002
1-800-554-JUMO
Fax: 610-380-8009
e-mail: info@JumoUSA.com
Internet: www.JumoUSA.com



Voltage table for thermocouples to EN 60 584

in mV for 10°C temperature steps (0°C cold junction)

NiCr-Ni K										
°C	0	-10	-20	-30	-40	-50	-60	-70	-80	-90
-200	-5.891	-	-	-	-	-	-	-	-	-
-100	-3.554	-3.852	-4.138	-4.411	-4.669	-4.913	-5.141	-5.354	-5.550	-5.730
0	0	-0.392	-0.778	-1.156	-1.527	-1.889	-2.243	-2.587	-2.920	-3.243

°C	0	10	20	30	40	50	60	70	80	90
0	0	0.397	0.798	1.203	1.612	2.023	2.436	2.851	3.267	3.682
100	4.096	4.509	4.920	5.328	5.735	6.138	6.540	6.941	7.340	7.739
200	8.138	8.539	8.940	9.343	9.747	10.153	10.561	10.971	11.382	11.795
300	12.209	12.624	13.040	13.457	13.874	14.293	14.713	15.133	15.554	15.975
400	16.397	16.820	17.243	17.667	18.091	18.516	18.941	19.366	19.792	20.218
500	20.644	21.071	21.497	21.924	22.350	22.776	23.203	23.629	24.055	24.480
600	24.905	25.330	25.755	26.179	26.602	27.025	27.447	27.869	28.289	28.710
700	29.129	29.548	29.965	30.382	30.798	31.213	31.628	32.041	32.453	32.865
800	33.275	33.685	34.093	34.501	34.908	35.313	35.718	36.121	36.524	36.925
900	37.326	37.725	38.124	38.522	38.918	39.314	39.708	40.101	40.494	40.885
1000	41.276	41.665	42.053	42.440	42.826	43.211	43.595	43.978	44.359	44.740
1100	45.119	45.497	45.873	46.249	46.623	46.995	47.367	47.737	48.105	48.473
1200	48.838	49.202	49.565	49.926	50.286	50.644	51.000	51.355	51.708	52.060
1300	52.410	52.759	53.106	53.451	53.795	54.138	54.479	54.819	-	-

NiCr-Con E										
°C	0	-10	-20	-30	-40	-50	-60	-70	-80	-90
-200	-8.824	-9.063	-9.274	-9.455	-9.604	-9.719	-9.797	-9.835	-	-
-100	-5.237	-5.680	-6.107	-6.516	-6.907	-7.279	-7.631	-7.963	-8.273	-8.561
0	0	-0.581	-1.151	-1.709	-2.254	-2.787	-3.306	-3.811	-4.301	-4.771

°C	0	10	20	30	40	50	60	70	80	90
0	0	0.591	1.192	1.801	2.419	3.047	3.683	4.329	4.983	5.646
100	6.317	6.996	7.683	8.377	9.078	9.787	10.501	11.222	11.949	12.681
200	13.419	14.161	14.909	15.661	16.417	17.178	17.942	18.710	19.481	20.256
300	21.033	21.814	22.597	23.383	24.171	24.961	25.754	26.549	27.345	28.143
400	28.943	29.744	30.546	31.350	32.155	32.960	33.767	34.574	35.382	36.190
500	36.999	37.808	38.617	39.426	40.236	41.045	41.853	42.662	43.470	44.278
600	45.085	45.891	46.697	47.502	48.306	49.109	49.911	50.713	51.513	52.312
700	53.110	53.907	54.703	55.498	56.291	57.083	57.873	58.663	59.451	60.237
800	61.022	61.806	62.588	63.368	64.147	64.924	65.700	66.473	67.245	68.015
900	68.783	69.549	70.313	71.075	71.835	72.593	73.350	74.104	74.857	75.608

Delivery address: Mackenrodtstraße 14,
36039 Fulda, Germany
Postal address: 36035 Fulda, Germany
Phone: +49 661 6003-0
Fax: +49 661 6003-607
e-mail: mail@jumo.net
Internet: www.jumo.net

JUMO House
Temple Bank, Riverway
Harlow, Essex CM 20 2TT, UK
Phone: +44 1279 635533
Fax: +44 1279 635262
e-mail: sales@jumo.co.uk
Internet: www.jumo.co.uk

885 Fox Chase, Suite 103
Coatesville PA 19320, USA
Phone: 610-380-8002
1-800-554-JUMO
Fax: 610-380-8009
e-mail: info@JumoUSA.com
Internet: www.JumoUSA.com



Tolerance classes

for thermocouples (0°C cold junction) to EN 60 584

Thermocouple	Operating range	Tolerance (±) ¹
copper/constantan T	-40 to + 350°C	0.5°C or 0.004 x ltl
iron/constantan J	-40 to + 750°C	1.5°C or 0.004 x ltl
nickel-chrome/constantan E	-40 to + 800°C	0.5°C or 0.004 x ltl
nickel-chrome/nickel K	-40 to +1000°C	1.5°C or 0.004 x ltl
platinum-13% rhodium/platinum R	0 to +1600°C	1 °C or [1+(t-1100) x 0.003]°C
platinum-10% rhodium/platinum S	0 to +1600°C	1 °C or [1+(t-1100) x 0.003]°C
platinum-30% rhodium/platinum-6% rhodium B	-	-

Thermocouple	Operating range	Tolerance (±) ¹
copper/constantan T	-40 to + 350°C	1 °C or 0.0075 x ltl
iron/constantan J	-40 to + 750°C	2.5°C or 0.0075 x ltl
nickel-chrome/constantan E	-40 to + 900°C	1 °C or 0.0075 x ltl
nickel-chrome/nickel K	-40 to +1200°C	2.5°C or 0.0075 x ltl
platinum-13% rhodium/platinum R	0 to +1600°C	1.5°C or 0.0025 x t
platinum-10% rhodium/platinum S	0 to +1600°C	1.5°C or 0.0025 x t
platinum-30% rhodium/platinum-6% rhodium B	+600 to +1700°C	1.5°C or 0.0025 x t

Thermocouple	Operating range	Tolerance (±) ¹
copper/constantan T	-200 to +40°C	1 °C or 0.015 x ltl
iron/constantan J	-200 to +40°C	2.5°C or 0.015 x ltl
nickel-chrome/constantan E	-200 to +40°C	1 °C or 0.015 x ltl
nickel-chrome/nickel K	-200 to +40°C	2.5°C or 0.015 x ltl
platinum-13% rhodium/platinum R	-	-
platinum-10% rhodium/platinum S	-	-
platinum-30% rhodium/platinum-6% rhodium B	+600 to +1700°C	4 °C or 0.005 x t

The standard tolerance for thermocouples corresponds to DIN 43 760 or EN 60 584, Class 2.

Restricted tolerance to Class 1 is possible on mineral-insulated thermocouples.

1. The tolerance is the specified value in °C or the percentage based on the actual temperature in °C, whichever is larger.

2. Thermocouples and thermocouple wires are usually supplied conforming to the tolerances according to the table above for the temperature range above -40°C.

At temperatures below -40°C, the deviations for thermocouples of the same material may exceed the tolerances for Class 3.

Where thermocouples according to tolerance classes 1, 2 and/or 3 are required, this has to be specified by the user;

specially selected material is then used.

Delivery address: Mackenrodtstraße 14,
36039 Fulda, Germany
Postal address: 36035 Fulda, Germany
Phone: +49 661 6003-0
Fax: +49 661 6003-607
e-mail: mail@jumo.net
Internet: www.jumo.net

JUMO House
Temple Bank, Riverway
Harlow, Essex CM 20 2TT, UK
Phone: +44 1279 635533
Fax: +44 1279 635262
e-mail: sales@jumo.co.uk
Internet: www.jumo.co.uk

885 Fox Chase, Suite 103
Coatesville PA 19320, USA
Phone: 610-380-8002
1-800-554-JUMO
Fax: 610-380-8009
e-mail: info@JumoUSA.com
Internet: www.JumoUSA.com



Voltage table to DIN 43710
im mV for 10°C temperature steps (0°C cold junction)

Cu-Con U

°C	0	-10	-20	-30	-40	-50	-60	-70	-80	-90
-200	-5.70	-	-	-	-	-	-	-	-	-
-100	-3.40	-3.68	-3.95	-4.21	-4.46	-4.69	-4.91	-5.12	-5.32	-5.51
0	0	-0.39	-0.77	-1.14	-1.50	-1.85	-2.18	-2.50	-2.81	-3.11

°C	0	10	20	30	40	50	60	70	80	90
0	0	0.40	0.80	1.21	1.63	2.05	2.48	2.91	3.35	3.80
100	4.25	4.71	5.18	5.65	6.13	6.62	7.12	7.63	8.15	8.67
200	9.20	9.74	10.29	10.85	11.41	11.98	12.55	13.13	13.71	14.30
300	14.90	15.50	16.10	16.70	17.31	17.92	18.53	19.14	19.76	20.38
400	21.00	21.62	22.25	22.88	23.51	24.15	24.79	25.44	26.09	26.75
500	27.41	28.08	28.75	29.43	30.11	30.80	31.49	32.19	32.89	33.60

Fe-Con L

°C	0	-10	-20	-30	-40	-50	-60	-70	-80	-90
-200	-8.15	-	-	-	-	-	-	-	-	-
-100	-4.75	-5.15	-5.53	-5.90	-6.26	-6.60	-6.93	-7.25	-7.56	-7.86
0	0	-0.51	-1.02	-1.53	-2.03	-2.51	-2.98	-3.44	-3.89	-4.33

°C	0	10	20	30	40	50	60	70	80	90
0	0	0.52	1.05	1.58	2.11	2.65	3.19	3.73	4.27	4.82
100	5.37	5.92	6.47	7.03	7.59	8.15	8.71	9.27	9.83	10.39
200	10.95	11.51	12.07	12.63	13.19	13.75	14.31	14.88	15.44	16.00
300	16.56	17.12	17.68	18.24	18.80	19.36	19.92	20.48	21.04	21.60
400	22.16	22.72	23.29	23.86	24.43	25.00	25.57	26.14	26.71	27.28
500	27.85	28.43	29.01	29.59	30.17	30.75	31.33	31.91	32.49	33.08
600	33.67	34.26	34.85	35.44	36.04	36.64	37.25	37.85	38.47	39.09
700	39.72	40.35	40.98	41.62	42.27	42.92	43.57	44.23	44.89	45.55
800	46.22	46.89	47.57	48.25	48.94	49.63	50.32	51.02	51.72	52.43



Electrical Temperature Measurement

with thermocouples and resistance thermometers

Matthias Nau

Electrical temperature sensors have become indispensable in automation and domestic engineering, as well as in production technology. As a result of the rapid expansion of automation in recent years, they have become firmly established in industrial engineering.

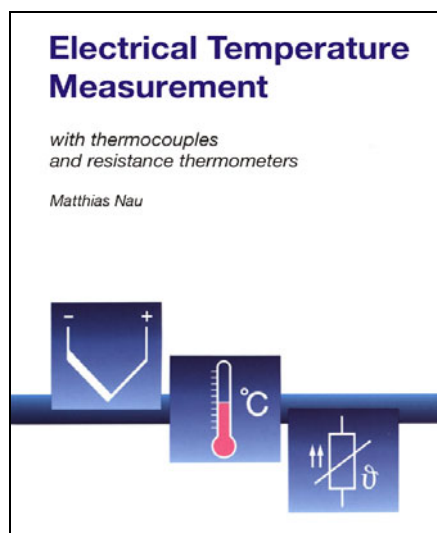

Fig. 13: Publication
Electrical temperature measurement with thermocouples and resistance thermometers

It is therefore particularly important that the user can select the product that best fits his application from the large variety of for available products for electrical temperature measurement.

On 160 pages this publication covers the theoretical fundamentals of electrical temperature measurement, the practical construction of temperature sensors, their standardization, tolerances and styles.

In addition, it describes in detail the different fittings for electrical thermometers, their classification to DIN and the great variety of applications. The book includes an extensive section with tables for voltage and resistance series to DIN and EN, thus making it a valuable guide both for the experienced practical engineer and the newcomer to the field of electrical temperature measurement.

You can order a copy under

Sales No. 90/00085081,
or download it from www.jumo.net
Because of the high handling costs, schools, institutes and universities are asked to place a bulk order.

Error Analysis of a Temperature Measurement System

with worked examples

Gerd Scheller

This 44-page publication helps in the evaluation of measurement uncertainty, particularly through the worked examples in Chapter 3. Where problems arise, we are glad to discuss specific problems with our customers, and to provide practical advice.

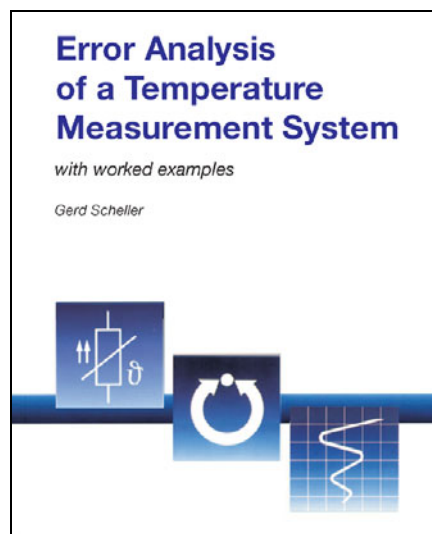

Fig. 14: Publication
Error analysis of a temperature measurement system, with worked examples

In order to be able to make comparable measurements, their quality must be established through details of the measurement uncertainty. The ISO/BIPM "Guide to the Expression of Uncertainty in Measurement", published in 1993 and usually referred to as GUM, introduced a standardized method for the determination and definition of measurement uncertainty. This method was adopted by calibration laboratories around the world. However, the application requires a certain level of mathematical understanding.

Further chapters present the topic of measurement uncertainty in a simplified and easily understandable fashion for all users of temperature measurement systems. Errors in the installation of the temperature sensors and the connections to the evaluation electronics lead to increased errors in measurement. To these must be added the measurement uncertainty components of the sensor and of the evaluation electronics itself. The explanation of the various components of measurement uncertainty is followed by some worked examples.

Knowledge of the various measurement uncertainty components and their magnitudes enable the user to reduce individual components through the selection of equipment or altered installation conditions. The decisive factor is always, which level of measurement uncertainty is acceptable for a specific measurement task. For instance, if a standard specifies tolerance limits for the deviation of a temperature from a nominal value, then the measurement uncertainty of the method used for temperature measurement should not be larger than 1/3 of the tolerance.

You can order a copy under
Sales No. 90/00415704

or download from www.jumo.net

Because of the high handling costs, schools, institutes and universities are asked to place a bulk order.

Delivery address: Mackenrodtstraße 14,
36039 Fulda, Germany
Postal address: 36035 Fulda, Germany
Phone: +49 661 6003-0
Fax: +49 661 6003-607
e-mail: mail@jumo.net
Internet: www.jumo.net

JUMO House
Temple Bank, Riverway
Harlow, Essex CM 20 2TT, UK
Phone: +44 1279 635533
Fax: +44 1279 635262
e-mail: sales@jumo.co.uk
Internet: www.jumo.co.uk

885 Fox Chase, Suite 103
Coatesville PA 19320, USA
Phone: 610-380-8002
1-800-554-JUMO
Fax: 610-380-8009
e-mail: info@JumoUSA.com
Internet: www.JumoUSA.com



German Calibration Service (DKD) at JUCHHEIM

Certification laboratory for temperature

Raised quality expectations, improved measurement technology and, of course, quality assurance systems, such as ISO 9000, make increasing demands on the documentation of processes and the monitoring of measuring devices.

In addition, there are increasing calls from customers for high product quality standards. Particularly stringent demands arise from ISO 9000 and EN 45 000, whereby measurements must be traceable to national or international standards. This provides the legal basis for obliging suppliers and manufacturers (of products that are subject to processes where temperature is relevant) to check all testing devices, which can affect the product quality, before use or at certain intervals. Generally, this is done by calibrating or adjusting using certified devices. Because of the high demand for calibrated instruments and the large number of instruments to be calibrated, the state laboratories have insufficient capacity. The industry has therefore established and also supports special calibration laboratories which are linked to the German Calibration Service (DKD) and are subordinate to the PTB (Physikalisch-Technische-Bundesanstalt) for all aspects of instrumentation.

The certification laboratory of the German Calibration Service at JUMO has carried out calibration certification for temperature since 1992. This service provides fast and economical certification for everyone.

DKD calibration certificates can be issued for resistance thermometers, thermocouples, measurement sets, data loggers and temperature block calibrators within the range -80 to +1100°C. The traceability of the reference standard is the central issue here. All DKD calibration certificates are recognized as documents of traceability, without any further specifications. The DKD calibration laboratory at JUMO has the identification DKD-K-09501-04 and is accredited to DIN EN ISO/IEC 17 025.