

JUMO GmbH & Co. KG
 Delivery address: Mackenrodtstraße 14,
 36039 Fulda, Germany
 Postal address: 36035 Fulda, Germany
 Phone: +49 661 6003-0
 Fax: +49 661 6003-607
 e-mail: mail@jumo.net
 Internet: www.jumo.net

JUMO Instrument Co. Ltd.
 JUMO House
 Temple Bank, Riverway
 Harlow, Essex CM 20 2TT, UK
 Phone: +44 1279 635533
 Fax: +44 1279 635262
 e-mail: sales@jumo.co.uk
 Internet: www.jumo.co.uk

JUMO PROCESS CONTROL INC.
 885 Fox Chase, Suite 103
 Coatesville PA 19320, USA
 Phone: 610-380-8002
 1-800-554-JUMO
 Fax: 610-380-8009
 e-mail: info@JumoUSA.com
 Internet: www.JumoUSA.com



LOGOSCREEN es



Paperless Recorder for secure acquisition of FDA-compliant measurement data

Brief description

Together with its PC software components, this paperless recorder provides a closed system for the electronic acquisition, storage and archiving of process data that fulfills the requirements of FDA 21 CFR Part 11.

The presentation is mainly determined by a 5.7" color screen, on which the measurement data are displayed in different formats (numbers, diagrams, bar graph...).

The integrated Security Manager ensures that only authorized persons can operate the instrument, and the integrated Audit-Trail Manager ensures seamless documentation of all operative actions.

Measurement data are electronically stored and available for evaluation both locally and on a PC. Front bezel size is 144 mm x 200 mm, maximum mounting depth is 228 mm.

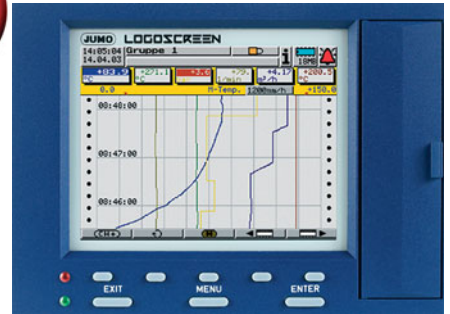

Type 706560/...

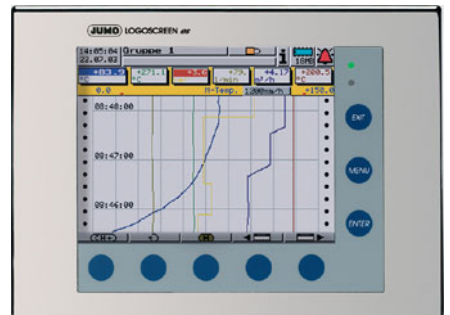

Type 706560/..., stainless steel front

Block structure

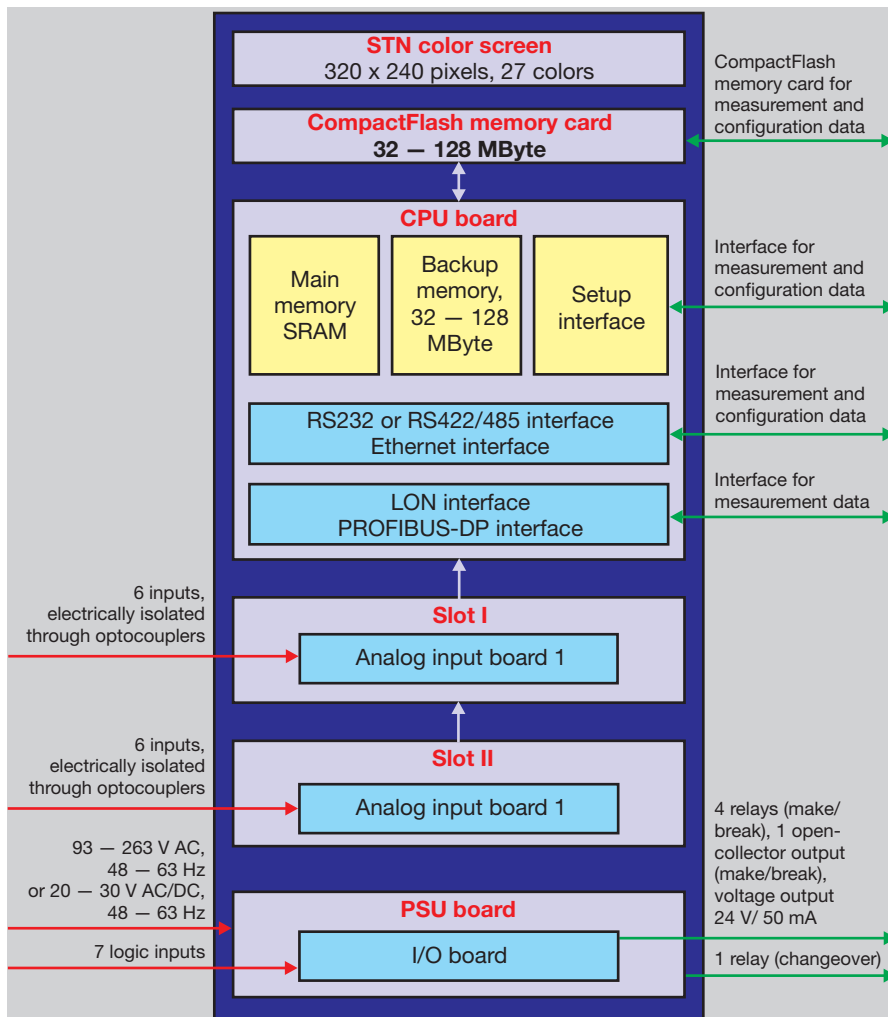

Features

- Conforms to FDA CFR Part 11
- monitored back-panel cover
- no chart/pens
- presentation of the measurement data in vertical/horizontal diagrams, bar graph, numerical, ...
- batch reporting
- local availability of the measurement data stored in RAM
- data records can be saved to a CompactFlash memory card
- instrument can be configured from the keypad, via the CompactFlash memory card or serial interface
- evaluation of the archived data through the PC evaluation software
- adaptation of the storage cycles to the individual process through
 - normal operation
 - event operation
 - day-time operation
- report with minimum/maximum/average values and integrator
- freely programmable inputs for resistance thermometers, thermocouples, DC current and DC voltage
- sampling cycle minimum 125msec with 12 analog inputs
- PROFIBUS-DP and Ethernet connection

Technical data

Internal analog inputs (channels 1 to 12)

Thermocouple

Designation	Type	Standard	Range	Linearization accuracy ¹
Fe-Con	L	DIN 43 710	-200 to + 900°C	±0.1 %
Fe-Con	J	EN 60 584	-210 to +1200°C	±0.1% above -100°C
Cu-Con	U	DIN 43 710	-200 to + 600°C	±0.1% above -150°C
Cu-Con	T	EN 60 584	-270 to + 400°C	±0.15% above -150°C
NiCr-Ni	K	EN 60 584	-270 to +1372°C	±0.1% above -80°C
NiCr-Con	E	EN 60 584	-270 to +1000°C	±0.1% above -80°C
NiCrSi-NiSi	N	EN 60 584	-270 to +1300°C	±0.1% above -80°C
Pt10Rh-Pt	S	EN 60 584	-50 to +1768°C	±0.15% above 0°C
Pt13Rh-Pt	R	EN 60 584	-50 to +1768°C	±0.15% above 0°C
Pt30Rh-Pt6Rh	B	EN 60 584	0 to 1820°C	±0.15% above 400°C
Shortest span			Types L, J, U, T, K, E, N: Types S, R, B:	100°C 500°C
Range start/end	freely programmable within the limits in 0.1 °C steps			
Cold junction	Pt100 internal or thermostat external constant			
Cold junction accuracy (internal)	± 1 °C			
Cold junction temperature (external)	-50 to +100°C, adjustable through setup software			
Sampling cycle	6 or 12 channels 125msec			
Input filter	2nd order digital filter; filter constant adjustable from 0 – 10.0sec			
Test voltage	500V (across optocoupler)			
Resolution	better than 14 bit			
Features	also programmable in °F			

1. The linearization accuracy refers to the maximum range span.
The linearization accuracy is reduced for shorter spans.

Resistance thermometers

Designation	Standard	Connection	Range	Linearization accuracy	Measuring current
Pt 100	EN 60 751	2/3-wire	-200 to +500°C	±0.4°C	500µA
		2/3-wire	-200 to +850°C	±0.8°C	250µA
		4-wire	-200 to +500°C	±0.4°C	500µA
		4-wire	-200 to +850°C	±0.5°C	250µA
Pt 100 JIS		2/3-wire	-200 to +500°C	±0.4°C	500µA
		2/3-wire	-200 to +650°C	±0.8°C	250µA
		4-wire	-200 to +500°C	±0.4°C	500µA
		4-wire	-200 to +650°C	±0.5°C	250µA
Pt 500	EN 60 751	2/3-wire	-200 to +500°C	±0.4°C	250µA
		2/3-wire	-200 to +850°C	±0.8°C	250µA
		4-wire	-200 to +500°C	±0.4°C	250µA
		4-wire	-200 to +850°C	±0.5°C	250µA
Pt 1000	EN 60 751	2/3-wire	-200 to +500°C	±0.4°C	500µA
		2/3-wire	-200 to +850°C	±0.8°C	250µA
		4-wire	-200 to +500°C	±0.4°C	500µA
		4-wire	-200 to +850°C	±0.5°C	250µA
Ni 100	EN 60 751	2/3-wire	-60 to +180°C	±0.4°C	500µA
		4-wire	-60 to +180°C	±0.4°C	500µA
Connection type	2-, 3- or 4-wire circuit				
Shortest span	15°C				
Probe lead resistance	max. 30 Ω per core for 3- and 4-wire circuit max. 10Ω per core for 2-wire circuit				
Range start/end	freely programmable within the limits in 0.1 °C steps				
Sampling cycle	6 or 12 channels 125msec				
Input filter	2nd order digital filter; filter constant adjustable from 0 – 10sec				
Test voltage	500V (across optocoupler)				
Resolution	better than 14 bit				
Features	also programmable in °F				

Resistance transmitter and potentiometer

Range	Accuracy	Measuring current
up to 180Ω	±150mΩ	500μA
up to 390Ω	±300mΩ	250μA
up to 2000Ω	±2Ω	500μA
up to 4000Ω	±4Ω	250μA
Connection type	resistance transmitter: 3-wire circuit potentiometer: 2-/3-wire circuit	
Shortest span	6Ω	
Probe lead resistance	max. 30Ω per core in 4-wire circuit max. 20Ω per core in 2- and 3-wire circuit up to 200Ω range: max. 10Ω per core in 2-and 3-wire circuit	
Resistance values	freely programmable within the limits in 0.1Ω steps	
Sampling cycle	6 or 12 channels 125msec	
Input filter	2nd order digital filter; filter constant adjustable from 0 – 10.0sec	

Input for DC voltage or DC current

Basic range	Accuracy	Input resistance
-20 to +70mV	±80μV	R _{IN} ≥ 1 MΩ
-5 to +105mV	±100μV	R _{IN} ≥ 1 MΩ
-10 to +210mV	±240μV	R _{IN} ≥ 1 MΩ
-0.5 to +12 V	±6mV	R _{IN} ≥ 470 kΩ
-0.05 to + 1.2V	±1mV	R _{IN} ≥ 470 kΩ
-1.2 to + 1.2V	±2mV	R _{IN} ≥ 470 kΩ
-12 to +12 V	±12mV	R _{IN} ≥ 470 kΩ
Shortest span	5mV	
Range start/end	freely programmable within the limits (up to 999mV in 0.01mV steps, above 1V in 1mV steps)	
-2 to +22mA	±20μA	burden voltage 1V max. burden voltage 1V max.
-22 to +22mA	±44μA	
Shortest span	0.5mA	
Range start/end	freely programmable within the limits in 0.1mA steps	
Sampling cycle	6 or 12 channels 125msec	
Input filter	2nd order digital filter; filter constant adjustable from 0 – 10.0sec	
Features	adjustable linearizations for thermocouples and resistance thermometers (for connection to transmitters without linearization)	

Transducer short-circuit/break

	Short-circuit ¹	Break ¹
Thermocouple	not detected	detected
Resistance thermometer	detected	detected
Resistance transmitter	detected	detected
Potentiometer	not detected	detected
Voltage up to ± 1V	not detected	detected
Voltage above ± 1V	not detected	not detected
Current	not detected	not detected

1. Programmable reaction of instrument, e.g. triggering alarm

Logic inputs (extra code)

Number	7 to DIN VDE 0411, Part 500; 25Hz max., 32V max.
Level	logic "0": -3 to +5V, logic "1": 12 to 30V
Sampling cycle	minimum 1 sec

Outputs

1 relay (ex-factory)	changeover, 3A, 230V AC ¹
4 relays (extra code)	make/break, 3A, 230V AC ¹
1 open-collector output (extra code)	25V max., 100mA max.

1. with resistive load. It is not permissible to mix SELV circuits and supply circuits.

Screen

Resolution	320 x 240 pixels
Size	5.7"
Number of colors	27 colors

Electrical data

Supply (switch-mode power supply)	110 – 240V AC +10/-15%, 48 – 63Hz or 20 – 30V AC/DC 48 – 63Hz
Electrical safety	to EN 61 010, Part 1, August 2002 overvoltage category II, pollution degree 2
Test voltages (type test)	
- mains supply circuit to measurement circuit	with AC supply: 3.7kV 50Hz, 1 min, with AC/DC supply: 510V 50Hz, 1 min
- mains supply circuit to housing (protective earth)	with AC supply: 2.3kV 50Hz, 1 min, with AC/DC supply: 510V 50Hz, 1 min
- measurement circuits to measurement circuit and housing	510V 50Hz, 1 min
- electrical isolation between the analog inputs	up to 30V AC and 50V DC
Supply voltage error	less than 0.1 % of span
Power consumption	25VA approx.
Data backup	see page 7
Electrical connection	at rear through plug-in screw terminals, max. conductor cross-section 2.5mm ² or 2x 1.5mm ² with ferrules

Environmental influences

Ambient temperature range	0 to +45°C
Ambient temperature error	0.03% per °C
Storage temperature range	-20 to +60°C
Climatic conditions	not exceeding 75% relative humidity, no condensation
EMC	EN 61 326
- interference emission	Class A
- immunity to interference	to industrial requirements

Housing

Housing front	zinc die-casting
Housing type	housing for flush-panel mounting to DIN 43 700, galvanized steel
Bezel size	200mm x 144mm
Depth behind panel	233mm
Panel cut-out	138 ^{+1.0} mm x 138 ^{+1.0} mm
Housing fixing	in panel to DIN 43 834
Operating position	unrestricted, taking into account the viewing angle of the screen, horizontal ±50°, vertical ±30°
Protection	to EN 60 529 Category 2, front IP54 (IP65 with extra code stainless steel front), rear IP20
Weight	3.5kg approx.

External analog measurement inputs / logic inputs / logic outputs

Type	JUMO mTRON automation system
Sampling cycle	1 sec
Technical data	see Data Sheet: 70.4015 Relay module 70.4020 Analog input module 70.4030 Logic module
Configuration	iTOOL Project design software (70.4090)

Operation and configuration

On the recorder

The instrument is configured from eight keys under menu guidance. Functions of 5 keys (softkeys) on the instrument alter according to the context so that there are always unique key functions during operation. Softkey functions are indicated on the screen in plain text or through symbols.

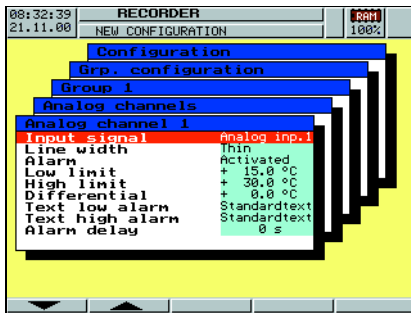

Integrated user lists (for various users with different access rights) protect the recorder from unauthorized access.

Via setup program for PC (extra code)

More conveniently than from the instrument keys, the recorder can be configured via the setup program for PC.

Communication between the PC setup program and the paperless recorder can be made through:

- the setup interface
- the serial interface
- the Ethernet interface, or
- the CompactFlash memory card.

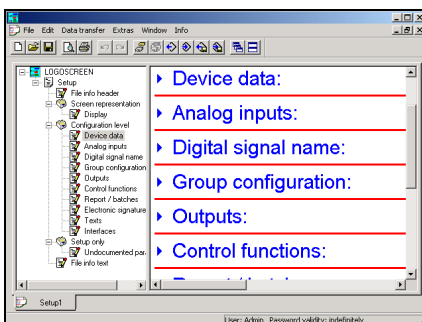

The configuration data can be archived on a data storage medium and can be output to a printer.

Via CompactFlash memory card

The configuration can be saved to a CompactFlash memory card, and read into the instrument from this card.

Operating language

The operating language for the instrument can be configured for different languages. English, German, French, Dutch, Italian, Spanish, Hungarian, Czech, Swedish, Polish, Danish, Finnish, Portuguese and Russian have already been implemented.

PC programs (accessories)

PC evaluation program (PCA 3000)

The PC evaluation program (PCA 3000) is a program which runs under Windows NT4.0/2000/XP, and is used to manage, archive, visualize and evaluate the recorder data.

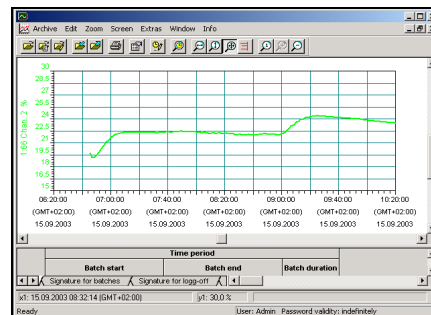

- The data of instruments with different configurations are recognized by the evaluation program and stored in an archive database. The complete management is performed automatically. The user only has to enter an identifier (supplementary description) manually.
- The user can at any time access specific sets of data which can be distinguished by the identifier. In addition, the time ranges to be evaluated can be limited.
- Any analog and digital channels of a paperless recorder can be subsequently combined into PCA groups in the PCA3000 software.
- Since each group is displayed in a separate window, several groups can be shown simultaneously on the screen and compared.
- Operation by mouse and keys.
- It is possible to export the stored data via the export filter, so that they can be processed in other programs, such as Excel.
- The PCA 3000 evaluation program has network capability, i.e. several users can obtain data from the same database in the network independently of each other.

PCA communications software (PCC)

- The data can be read out from the paperless recorder via the serial interface (RS232/RS422/RS485). The data can be read out either manually or automatically (e.g. daily at 23 hrs).
- Data can also be retrieved via remote control, through a modem.

PC Security Manager (PCS)

- Software for the administration of access control. This software is only accessible for administrators.

PC Audit-Trail Manager

- Software for the documentation of operational actions that could lead to alterations in the data records.

Interfaces

- Setup interface (fitted as standard)
- RS232 interface (fitted as standard)
- RS422/485 interface (extra code)
- Ethernet interface (extra code)
- LON interface (extra code)
- PROFIBUS-DP interface (extra code)

Setup interface

The setup interface is used together with the PC interface cable (including the TTL/RS232 converter and adapter) for operation of the PC setup program (see Page 5). The paperless recorder has setup interfaces (connected in parallel) on both the front and back panels. They cannot both be used at the same time.

RS232 interface

RS422/485 interface

The current process data, as well as specific instrument data, can be read out via the RS232 or RS422/RS485 interfaces.

The data that are stored in the backup memory can also be read out in conjunction with the PC evaluation software PCA3000 and the PCA communications software (PCC).

Normally, the instrument is supplied with a RS232 interface which allows for a lead length of maximum 15 meters. The RS422/RS485 interface permits a lead length of 1.2 km.

Connection is by a 9-pin SUB-D connector at the back of the instrument. Modbus and Jbus protocols are available, and the transmission mode used is RTU (Remote Terminal Unit).

Ethernet interface

The Ethernet interface can be used in local networks for communication between the paperless recorder and the PC setup program or the PCA communications software. The IP address is given a fixed setting through configuration on the instrument or in the PC setup program.

When using the Ethernet interface, care must be taken to ensure that only one client at a time is permitted to access the instrument (server).

Transmission protocol: TCP/IP

Network type: 10BaseT

	Setup interface	RS232 RS422 RS485	Ethernet	PROFI-BUS-DP	LON	External CF card
Read/write measurements (present data)	yes	yes	yes	yes	yes	no
Read measurements (stored data)	yes	yes	yes	no	no	yes
Read/write configuration	yes	yes	yes	no	no	yes
Write user list	yes	yes	yes	no	no	yes
Read screen memory	yes	yes	yes	no	no	no

PROFIBUS-DP interface

The paperless recorder can be integrated into a fieldbus system according to the PROFIBUS-DP standard, via the PROFIBUS-DP interface. This PROFIBUS variant is particularly suitable for the communication between automation systems and distributed peripheral devices at the field level.

Data transmission takes place serially according to the RS485 standard, at a maximum of 12Mbit/sec.

Using the project design tool that is included in the delivery (GSD generator; GSD = Device Base Data), an application-specific GSD file is created, which is used to integrate the paperless recorder into the fieldbus system.

Up to 36 channels can be read in via the PROFIBUS.

LON interface

The LON interface is used to expand the measurement channels (channels 13 – 36) through modules from the JUMO mTRON automation system.

External CompactFlash memory card (CF)

The external CompactFlash memory card is used to transfer the data from the backup memory to the PC. Configuration data can be created on the PC and then transferred to the paperless recorder by means of the memory card.

On the PC side, data on the card is accessed with the help of a CompactFlash reader/writer.

Data processing

Data recording

The measurements of the analog inputs are acquired continuously in a 125msec sampling cycle. Based on these measurements, reports are compiled and limits monitored.

Depending on the programmable storage cycle and stored value (maximum/minimum/average or instantaneous value), the measurements are transferred to the main memory of the instrument.

Main memory (RAM)

The data which are stored in the RAM are regularly copied to the internal backup memory in 10 kByte blocks. This is written to as a ring memory, i.e. when the RAM is full, the oldest data will automatically be overwritten by new data. The storage capacity is sufficient for 350,000 measurements.

The data from the main memory can be shown as a history presentation on the paperless recorder.

Backup memory (internal)

When a block of the main memory has been filled it is copied to the backup memory. The backup memory has a capacity of 32 – 128 MByte.

Every write action is monitored, so that any errors in saving data can be immediately identified.

The instrument monitors the capacity of the internal backup memory and activates one of the "memory alarm" signals when the capacity has fallen below the configurable residual capacity level. These signals can be used, for instance, to operate a relay.

CompactFlash memory card (external)

The external (replaceable) CompactFlash memory card can be used to transfer the data to a PC.

Data security

The data are stored in coded form in a proprietary format. This ensures a high level of data security.

If the paperless recorder is disconnected from the supply, then:

- RAM and clock time are buffered by a lithium battery (ex-factory) for more than 4 years, or more than 2 days with a storage capacitor (at 15 to 25°C ambient temperature)
- measurement data in the backup memory will not be lost
- configuration data are saved in the non-volatile Flash memory

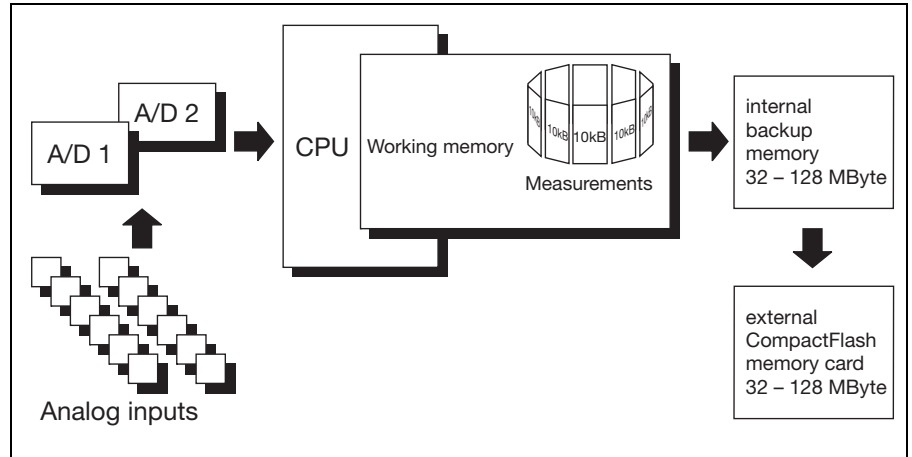

Recording duration

Depending on the configuration of the instrument, the duration of the recording can vary over a considerable range (from a few days up to several months).

Data transfer

Data transfer from the paperless recorder to a PC is made by means of the external CompactFlash memory card, via the serial interface, or via the Ethernet interface.

Reports

For each input, a report (maximum/minimum/average and integrator) can be run over a pre-defined period.

Batch reports

Batch reporting can be performed in conjunction with an external report. Start, end and duration of a batch are recorded. Together with a batch counter and freely definable texts, these times can be displayed on the paperless recorder and within the PC evaluation software PCA3000.

Batch reporting can, for instance, be started by

- logic inputs 1 – 7 (extra code)
- Modbus flag (serial interface)
- external logic inputs 1 – 6 (JUMO mTRON system)

Limit monitoring/ change of operating mode

Over/underlimit conditions trigger an alarm. The alarm can be used, for instance, as a control signal to switch the operating mode from normal/timed operation to event operation.

The storage cycle and stored value can be configured separately for all three operating modes.

With the help of the alarm delay function, brief occurrences of over/underlimit conditions can be filtered out, with the result that no alarm is produced.

Normal operation

If no alarm is present and the instrument is **not** in timed operation, normal operation is active.

Event operation

Event operation is activated/deactivated by a control signal (log. input, group/com-bination alarm, ...). As long as the control signal is active, the recorder is in event operation.

Timed operation

Timed operation is active on a daily basis for a programmable period of time. The operating modes have different priorities:

Operating mode	Priority
Event operation	1 (higher)
Timed operation	2
Normal operation	3 (lower)

Presentation modes on the recorder

Group manager

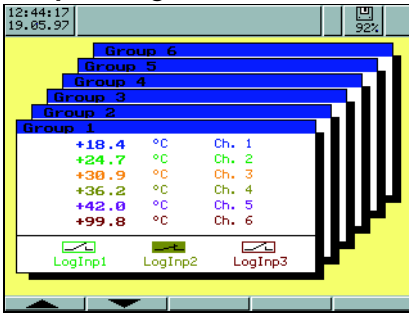

- 6 groups, each with any 6 analog and 3 logic inputs
- one input can be assigned to several groups
- display of present measurements or states of inputs
- groups can be active/inactive

Bar graph presentation

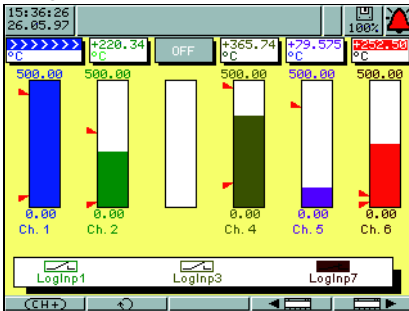

- bar graph presentation of the analog channels
- on/off presentation of the digital channels
- display of the present analog channels with scaling and limit markers
- color change of bar graph to red on overlimit condition

Report

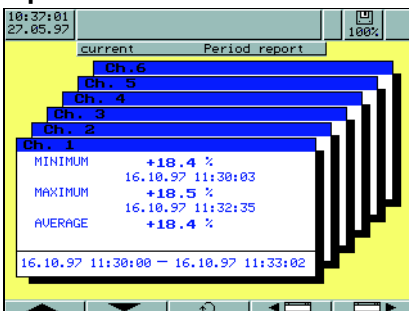

- report of one analog channel in its own window
- indication of minimum, maximum, average/integral value and time period
- display of previous report

Vertical diagram

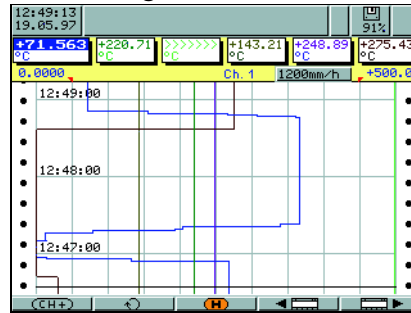

- recorder chart presentation of the analog channels
- scaling and limit marker indication on one channel
- numerical display of the present analog channels

Horizontal diagram



- graphical presentation of the analog and digital channels
- scaling and limit marker indication on one channel
- numerical display of the present measurements of the analog channels

Numerical presentation

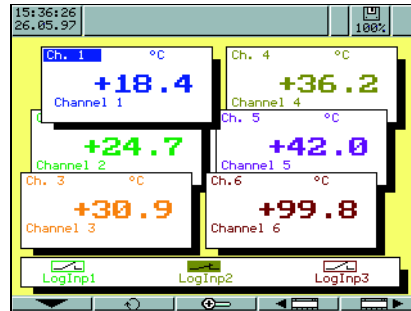

- large numerical presentation of the analog channels, including the 2-line channel description
- each analog channel can be switched to the foreground
- on/off presentation of the digital channels

Numerical 1-channel presentation

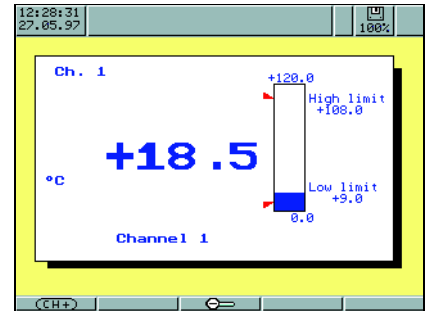

- clear presentation of one analog channel
- one analog channel is presented simultaneously as bar graph and number
- display of the 2-line channel designation
- indication of scaling and limit markers

History presentation vert./horiz.

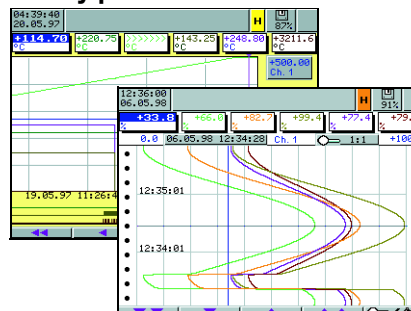

- graphical presentation of all stored measurement data at different zoom levels
- indication of scaling and limit markers for one channel
- numerical display of the measurements of the analog channels at the cursor position
- shifting of the visible window within the stored measurement data

History analysis

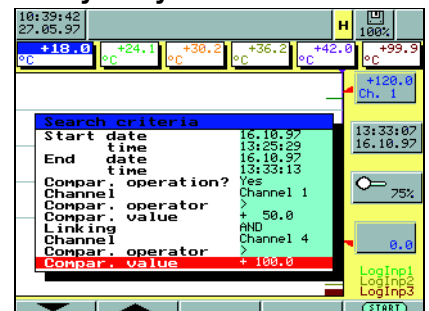

- restriction to a specific time period

Connection diagram

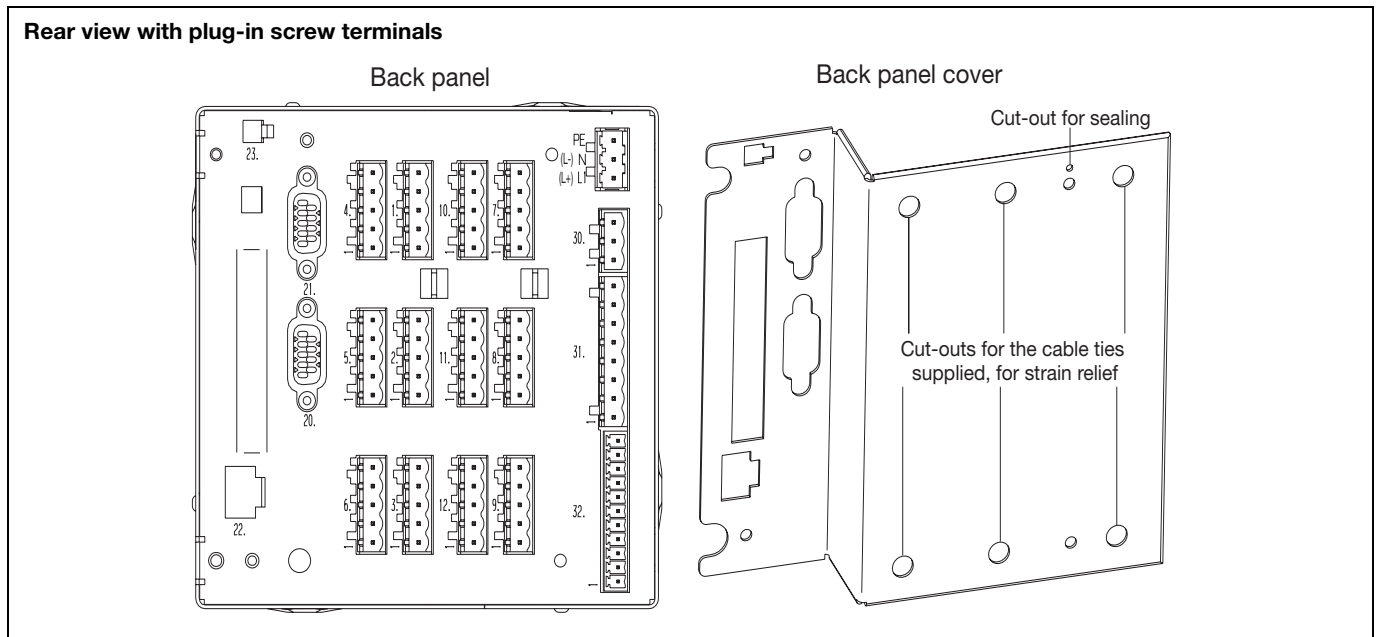

Terminal assignment	Connector	Diagram
Supply voltage		
Supply voltage as per nameplate	L1 (L+) N (L-) PE	
Analog inputs		
Thermocouple	1 to 12	
Resistance thermometer in 2-wire circuit	1 to 12	
Resistance thermometer in 3-wire circuit	1 to 12	
Resistance thermometer in 4-wire circuit	1 to 12	
Resistance transmitter	1 to 12	
Potentiometer in 2-wire circuit	1 to 12	
Potentiometer in 3-wire circuit	1 to 12	

Potentiometer in 4-wire circuit	1 to 12	
Voltage input up to 200mV	1 to 12	
Voltage input above 200mV	1 to 12	
Current input	1 to 12	
Digital interfaces		
RS232C 9-pin SUB-D socket	20	2 RxD receive data 3 TxD transmit data 5 GND ground
RS422 9-pin SUB-D socket (extra code)	20	3 TxD+ transmit data + 4 RxD+ receive data + 5 GND ground 8 TxD- transmit data - 9 RxD- receive data -
RS485 9-pin SUB-D socket (extra code)	20	3 TxD+/RxD+ transmit/receive data + 5 GND ground 8 TxD-/RxD- transmit/receive data -
LON interface 9-pin SUB-D socket (extra code)	21	3 Net_A 9 Net_B
PROFIBUS-DP 9-pin SUB-D socket (extra code)	21	3 RxD/TxD-P receive/transmit data-Plus B-cable 5 DGND data transmission potential 6 VP supply voltage-Plus 8 RxD/TxD-N receive/transmit data-N A-cable
Ethernet RJ45 socket (extra code)	22	1 TX+ transmit data + 2 TX- transmit data - 3 RX+ receive data + 6 RX- receive data -
Setup interface	23	The paperless recorder also has a setup interface on the front panel (wired in parallel). It is not possible to use both at the same time.
Relay outputs		
Relay K1 (changeover)	30	
Relay K2 to K5 (make/break) (extra code)	31	

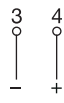
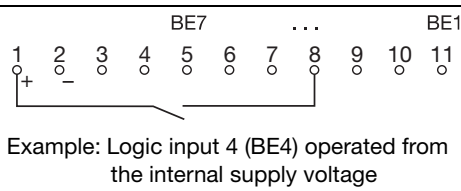
Digital I/O		
Open-collector output (extra code)	32 3 ground 4 collector	
Logic inputs (extra code) voltage-operated LOW = -3 to +5V DC HIGH = 12 to 30V DC Supply 24V/50mA	32 1 +24V auxiliary supply not stabilized 2 GND 5 logic input 7 ... 11 logic input 1	

Dimensions (also for stainless steel front)

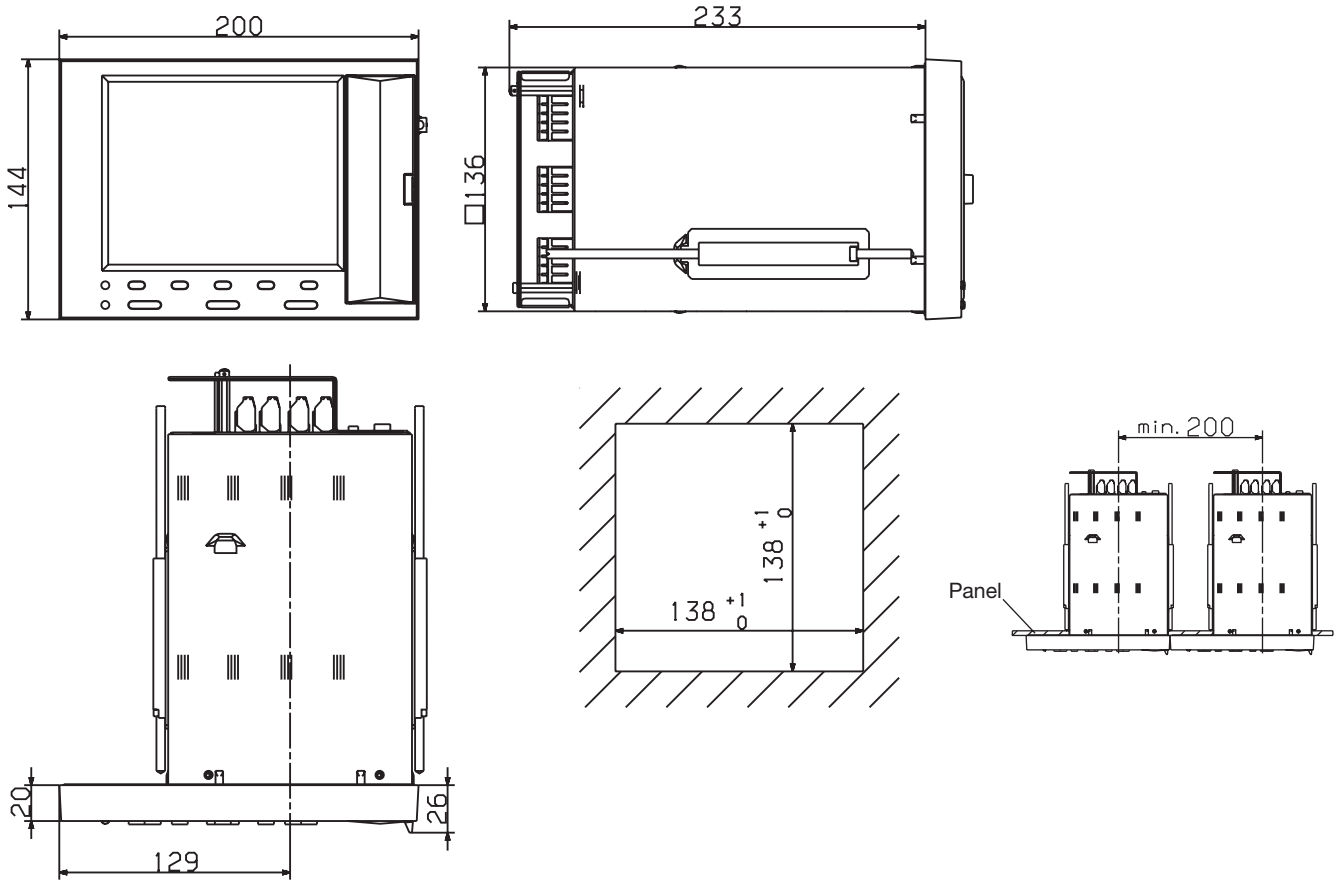

Extra code: universal carrying case TG-35 and stainless steel front

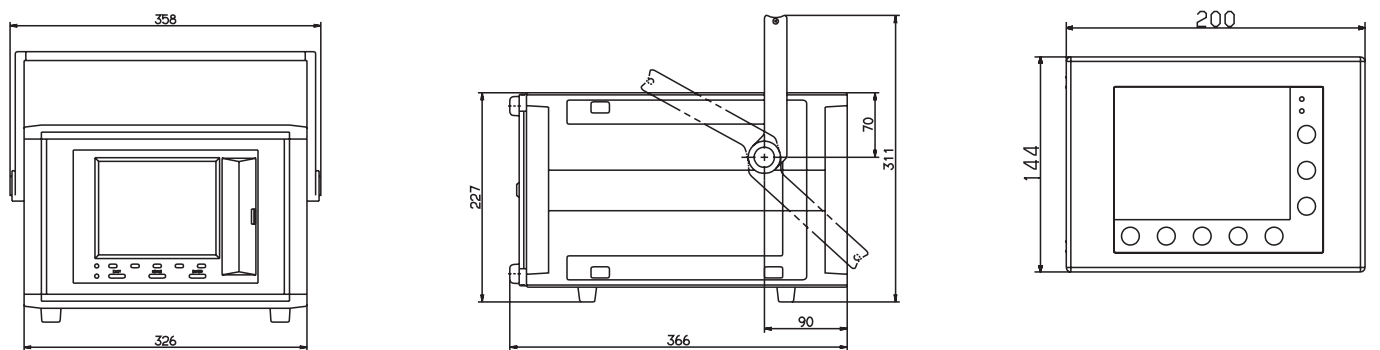

Order details

LOGOSCREEN es
Paperless Recorder for secure acquisition of FDA-compliant measurement data

(1) Basic version

	706560/00	paperless recorder without analog inputs
	706560/01	paperless recorder without analog inputs incl. PC software package and interface cable/adapter
	706560/10	paperless recorder with 6 analog inputs
	706560/20	paperless recorder with 6 analog inputs incl. PC software package and interface cable/adapter
	706560/11	paperless recorder with 12 analog inputs
	706560/21	paperless recorder with 12 analog inputs incl. PC software package and interface cable/adapter
	(2) Inputs 1 – 6 (programmable)	
	000	not assigned
	888	factory-set
	(3) Inputs 7 – 12 (programmable)	
	000	not assigned
	888	factory-set
	(4) Interface	
	51	RS232C (standard)
	54	RS422/485
	66	RS232C and LON
	67	RS422/485 and LON
	68	RS232C and PROFIBUS-DP
	69	RS422/485 and PROFIBUS-DP
	(5) Internal memory	
	0032	32 MB backup memory
	0064	64 MB backup memory
	0128	128 MB backup memory
	(6) External memory	
	0000	without external memory
	0032	32 MB CompactFlash memory card
	0064	64 MB CompactFlash memory card
	0128	128 MB CompactFlash memory card
	(7) Supply	
	23	110 – 240V AC +10/-15%, 48 – 63Hz
	25	20 – 30V AC/DC 48 – 63Hz
	(8) Extra codes	
x	008	Ethernet connection
x	020	lithium battery for memory buffer (ex-factory)
x	061	UL approval
x	021	storage capacitor (instead of extra code 020)
x	258	7 logic inputs, 1 open-collector output, 4 relay outputs, voltage output 24V DC 50mA
x	350	universal carrying case TG-35 ²
x	444	stainless steel front with membrane keypad

Order code

Order example

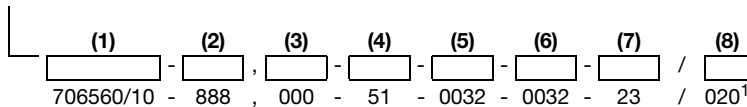

- List extra codes one after another, separated by commas.
- The UL approval (061) only applies to the panel-mounting instrument.

Standard accessories

- instrument documentation
- 2 fixing brackets
- 4 cable-ties with foot (can be released) for strain relief of the attached sensor cables

Accessories (Data Sheet 70.9700)

- PC software package consisting of: setup software, PC evaluation software (PCA3000), PCA communications software (PCC), PC Security Manager (PCS) and PC Audit-Trail Manager (PCAT)

Please specify all version numbers when placing repeat orders.

- PC interface cable with TTL/RS232 converter and adapter Sales No. 70/00350260
- Documentation IQ / OQ german-english Sales No. 70/00436829
- Documentation IQ / OQ french-english Sales No. 70/00441797

Supplementary accessory: Universal carrying case TG-35

